



SIGNPOST BROCHURE

## System solutions for industry, commerce and local authorities











**Futureproof energy  
systems**

Perfectly matched  
system components  
from a single source



# Table of contents

<b>RANGE OF SOLUTIONS</b>	<b>4</b>
Viessmann's integrated range of solutions	4
Digital services and value added services	5
<b>MODERNISATION AND NEW BUILD</b>	<b>6</b>
Efficient modernisation of existing buildings	6
Comprehensive energy supply for residential complexes	7
Local heating networks	8
<b>GAS CONDENSING BOILERS</b>	<b>10</b>
Vitocrossal 300	12
Vitocrossal 200	14
<b>LOW TEMPERATURE OIL/GAS BOILERS</b>	<b>16</b>
Vitoradial 300-T	18
Vitotrans heat exchangers	20
<b>COMBINED HEAT AND POWER UNITS</b>	<b>22</b>
Vitobloc 300	24
Vitobloc 200	26
<b>BIOMASS BOILERS</b>	<b>28</b>
<b>LARGE HEAT PUMPS</b>	<b>30</b>
Geothermal probes	33
<b>ICE ENERGY STORES</b>	<b>34</b>
<b>STEAM AND HOT WATER BOILERS</b>	<b>36</b>
Automation and control technology	39
Modular range of industrial/commercial boilers	40
<b>SYSTEMATIC SOLUTIONS</b>	<b>42</b>
<b>MULTI MODE SYSTEM CONTROLLERS</b>	<b>44</b>
<b>CLOUD-BASED ONLINE MONITORING</b>	<b>46</b>
<b>CONNECTIVITY</b>	<b>48</b>
<b>WATER HEATERS</b>	<b>50</b>
<b>HEAT INTERFACE UNITS</b>	<b>52</b>
<b>VACUUM TUBE COLLECTORS</b>	<b>54</b>
<b>CONTAINER HEATING SYSTEMS</b>	<b>56</b>
<b>PLANNING SOFTWARE</b>	<b>58</b>
<b>VALUE ADDED SERVICES</b>	<b>60</b>
<b>THE COMPANY</b>	<b>62</b>

<p><b>Value added services</b></p>	<p>Wärme    ViShare*    Strom    FörderProfi                  Leads    Service Plus    Logistik Plus    ...</p>
<p><b>Digital services</b></p>	<p> ViCare     ViGuide     ViScada    ...</p>
<p><b>Connectivity &amp; platforms</b></p>	<p> Connectivity Inside     Energy Management Inside    Vitoconnect    Vitocontrol   Wibutler     GridBox    ...</p>
<p><b>Products &amp; systems</b></p>	

**This brochure provides an overview of Viessmann's integrated range of solutions for industry, commerce and local authorities.**

\* Energy Market Solutions GmbH (EMS), a stakeholder in the Viessmann Group, is the operator and contractual partner in the ViShare Energy Community.

# Viessmann's integrated range of solutions

Viessmann is a leading manufacturer of climate solutions for all living spaces. "Viessmann's integrated range of solutions" makes it possible to connect products and systems via digital platforms and services. These solutions are based on renewable energies and maximum efficiency. Every initiative of Viessmann, a family-owned company founded in 1917, springs from the corporate mission statement: "We create living spaces for generations to come". Doing so is the responsibility of the Viessmann family with its 12,750 members worldwide.

## **Products and systems**

The foundation is the comprehensive range for heat, electricity, cooling and steam. Here, Viessmann offers products and systems that integrate the right energy sources into municipal, commercial and industrial environments.

## **Connectivity and platforms**

Connectivity is an essential element of Viessmann's integrated range of solutions. Vitocontrol is a powerful system controller for multi mode systems – from predefined system examples to individual solutions. The option to integrate the Vitocontrol system controller into a building management system puts the finishing touch to the range.

## **Digital services**

The innovative ViScada (Viessmann Supervisory Control and Data Acquisition) web solution gives system users and trade partners a comprehensive and transparent visualisation of multiple multi mode energy systems, all the way down to individual system components.

ViScada informs the user about the system status in real time. The values on the generation and consumption side

are shown. On this basis, the system characteristics can be evaluated at a glance and, if necessary, parameters can be optimised online.

## **Value added services**

Today, complex energy centres must fulfil a multitude of specifications. This applies in particular when an energy system undergoes modernisation. In addition to the efficient provision of energy with low emissions, the implementation of a project also depends on high operational reliability and system availability. Viessmann meets these requirements with customised solutions. For industrial applications, commercial enterprises and local authorities, this includes a professional consultation, a comprehensive range of services and reliable, durable products for an economical and futureproof energy supply.

## Efficient modernisation of existing buildings



This fully modernised high-rise apartment building in Pforzheim relies one hundred percent on renewable energy sources.

The thorough modernisation of a high-rise apartment building in Pforzheim also included a completely new energy system. It relies one hundred percent on renewable energy sources, meaning that it achieves the energy standard of a zero-energy house. The low annual heating energy demand is covered by an ice energy store system with solar/air absorbers integrated into the façade. Power comes from photovoltaic modules and a small wind power system on the roof.

The results are impressive: before the modernisation, the building's annual heating energy demand was 195.7 kWh/m<sup>2</sup>a with CO<sub>2</sub> emissions of 65.9 kg/m<sup>2</sup>a. Thanks to the new, very well insulated façade with triple-glazed windows, these values are now just 12 kWh/m<sup>2</sup>a and 6 kg/m<sup>2</sup>a respectively. For the tenants, energy costs have dropped to only ten percent of the previous levels.



Interior view of an ice energy store – shown here in its frozen state.



The Vitocal 300-G brine/water heat pumps each have an output of 12.6 kW.

# Comprehensive energy supply for residential complexes

Siedlungswerk Stuttgart has implemented the development and construction of 500 apartments in the Rosenstein Quarter, based on the principle of sector coupling: in addition to an ice energy store as the primary energy source for heating and cooling, a Vitocal 350-G Pro large heat pump, a Vitobloc 200 combined heat and power unit (CHP unit), a Vitocrossal 300 gas condensing boiler and a Vitovolt 300 photovoltaic system (PV system) supply the building complex with energy.

This modern, inner-city residential quarter in the immediate vicinity of the new S21 long-distance railway station focuses on urban living without the need to own a car. Instead, residents can use a car-sharing system with electric vehicles. The electricity needed to charge the electric cars is generated by the CHP unit and PV modules within the Quarter itself. Surplus electricity is stored in a power storage system and delivered to the consumers in the households when needed.



The Rosenstein Quarter in Stuttgart: 500 apartments have been constructed here according to the principle of sector coupling.



Interior view of an ice energy store.



The Vitobloc 200 CHP unit supplies the electricity to operate the heat pump.

## Premium fashion producer uses renewable heat and self-generated power



The snow-white production, warehouse and administration buildings of Marc Cain GmbH are nestled in a park-like setting with English lawns and ponds. Here at the head office in Bodelshausen, not far from Tübingen, you can still find one of a small number of clothing companies that made the textile region of the Swabian Alb famous.

Founded in 1973, the company is a globally operating premium women's fashion brand with a proportion of its production operations in Germany, employing around 1000 people. Its selective distribution strategy includes 210 Marc Cain stores, 292 shop-in-stores, 397 account customers and a further 1087 upmarket specialist shops in 61 countries.

To ensure competitiveness, around 82 million euros were recently invested in administration, production and research and development. 35 million euros alone went into a state of the art logistics centre. A large proportion of this investment was assigned to the construction of a new energy centre at the company's head office in Bodelshausen. Now, thanks to a highly efficient energy system from Viessmann, the fashion manufacturer heats its buildings with renewable energy and also generates its own power.

### **On-site local heating replaces district heating**

In 2015, the company switched over from the previous district heating



provided by a local power supply utility to take advantage of its newly installed on-site heating centre, connected to a local heating network. "The district heating supply didn't work out the way we envisaged," explains Harald Scherm, who is responsible for building services at Marc Cain. "A decision was therefore taken to invest in our own local heating network at the same time as building our new logistics centre," Mr. Scherm continues. This network supplies the entire Marc Cain Campus, which has a total floor space of over 55,000 square metres.

#### **Fully automatic pellet boiler covers the base heat load**

In order to meet the requirements of the German Energy Saving Ordinance (EnEV), the company opted for biomass as the primary energy source right from the outset. According to the Ordinance, 25 percent of the energy required for heat generation in new builds must come from renewable resources.

A Vitoflex 300-UF pellet boiler with an output of 950 kilowatts was therefore chosen to meet the base load demand for heating energy and hot water. Automatic functions such as fuel feed, ash removal and pneumatic heating surface cleaning, together with

sophisticated safety equipment, ensure convenient and safe operation, whilst the combination of innovative combustion technology and modulating output control enables efficiency levels of up to 95 percent to be achieved. A cyclone filter and an electrostatic filter retain all suspended particles in the flue gas, thereby guaranteeing low emissions. The fully automatic biomass boiler also offers maximum flexibility in terms of using different fuels. "Compared to woodchips, the use of pellets proved to be more maintenance friendly," says Harald Scherm, explaining the decision to use wood pellets as fuel. He continues: "Another advantage was that all Viessmann components were supplied from a single source."

Peak loads are covered by a Vitocrossal 300 gas condensing boiler. The special design of its heat exchanger surfaces enables high outputs to be achieved whilst retaining compact dimensions and low weight.

Four heating water buffer cylinders with a total volume of 20,000 litres were installed to store the generated heat. The hot water is supplied by a Vitocell 100-V DHW cylinder with a capacity of 300 litres.

#### **CHP and photovoltaics for self-generation**

To enable the highest possible level of independence from the public grid, a Vitobloc 200 EM-20/39 CHP unit and a photovoltaic system with an output of 450 kW<sub>p</sub> were installed. The CHP unit with an electrical output of up to 20 kilowatts was supplied as a prefabricated compact module with the result that it could be commissioned very quickly. It is used to supply heat and electricity according to demand. With integrated condensing technology, it uses the heat contained in the exhaust gases and converts up to 95 percent of the fuel used into heat.

#### **Fully networked with the building management system**

All energy generators are networked into the building management system and can be operated and monitored remotely at any time.



Vitoflex 300-UF pellet boiler with a heating output range from 300 to 950 kW



Vitobloc 200 EM-20/39 CHP unit with outputs of 20 kW<sub>el</sub> and 39 kW<sub>th</sub>



The Vitocrossal 300 gas condensing boiler (type CR3B) is designed for an output of up to 787 kW and serves as a peak load boiler.

## Gas condensing boilers

---



### VITOCROSSAL 300

#### Gas condensing boiler

##### Type CT3U

135 – 400 / 168 – 500 / 209 – 630 kW

Standard seasonal efficiency [to DIN]: up to 98 % (H<sub>g</sub>) [gross cv]

---



### VITOCROSSAL 300

#### Gas condensing boiler

##### Type CT3B

187 / 248 / 314 / 408 / 508 / 635 kW

Standard seasonal efficiency [to DIN]: up to 98 % (H<sub>g</sub>) [gross cv]

---



### VITOCROSSAL 300

#### Gas condensing boiler

##### Type CR3B

787 / 978 / 1100 / 1400 kW

Standard seasonal efficiency [to DIN]: up to 98 % (H<sub>g</sub>) [gross cv]

---



### VITOCROSSAL 300

#### Gas condensing boiler

##### Type CRU

800 / 1000 kW

Standard seasonal efficiency [to DIN]: up to 98 % (H<sub>g</sub>) [gross cv]

---



**VITOCROSSAL 200**

**Gas condensing boiler**

**Type CIB**

80 / 120 / 160 / 200 / 240 / 280 / 318 kW

Twin boiler in a single casing up to 636 kW

Standard seasonal efficiency [to DIN]: up to 98 % (H<sub>2</sub>) [gross cv]



**VITOCROSSAL 200**

**Gas condensing boiler**

**Type CM2B**

29 – 87 / 38 – 115 / 47 – 142 / 62 – 186 / 82 – 246 / 104 – 311 kW

Standard seasonal efficiency [to DIN]: up to 98 % (H<sub>2</sub>) [gross cv]



**VITOCROSSAL 200**

**Gas condensing boiler**

**Type CM2**

400 / 500 / 620 kW

Standard seasonal efficiency [to DIN]: up to 98 % (H<sub>2</sub>) [gross cv]



Scan the QR code for further information  
about gas condensing boilers.



Vitocrossal 300 gas condensing boiler (type CR3B)  
787 to 1400 kW



Inox-Crossal heat exchanger for highly effective heat transfer  
and a high condensation rate

The Vitocrossal 300 (type CR3B) is a premium product amongst floorstanding gas condensing boilers. As a single boiler system with an output range from 787 to 1400 kilowatts, it is the most powerful boiler of its kind. This makes it just as suitable for residential complexes as for local heating networks, larger public and commercial buildings and industrial plants.

#### **Sectional design to facilitate handling**

The special design of the Inox-Crossal heat exchanger enables a large output range of 787 to 1400 kilowatts, whilst retaining its modest dimensions and low weight. The heat exchanger module and combustion chamber module can be separated to facilitate transport.

Highly effective heat transfer and a high condensation rate enable standard seasonal efficiency [to DIN] of up to 98 percent ( $H_g$ ) [gross cv]. These values are the result of the countercurrent principle related to hot gas and boiler water, along with intensive turbulence of the hot gases as they pass through the heat exchanger.

A second return connector ensures a particularly favourable hydraulic connection in conjunction with the use of condensing technology. Vitocrossal 300 gas condensing boilers are available factory-fitted with Weishaupt or ELCO pressure-jet gas burners.

#### **Convenient Vitotronic control unit**

The integral Vitotronic control unit with its large colour touchscreen is easy and intuitive to use. An assistant function helps with commissioning.

The boiler can be connected directly to Vitodata via a Vitocom interface. This enables the contractor to provide additional digital services to ensure reliable system operation. The Vitosoft 300 service tool communicates directly via WiFi.

Energy consumption can be clearly visualised with the control unit's energy cockpit.

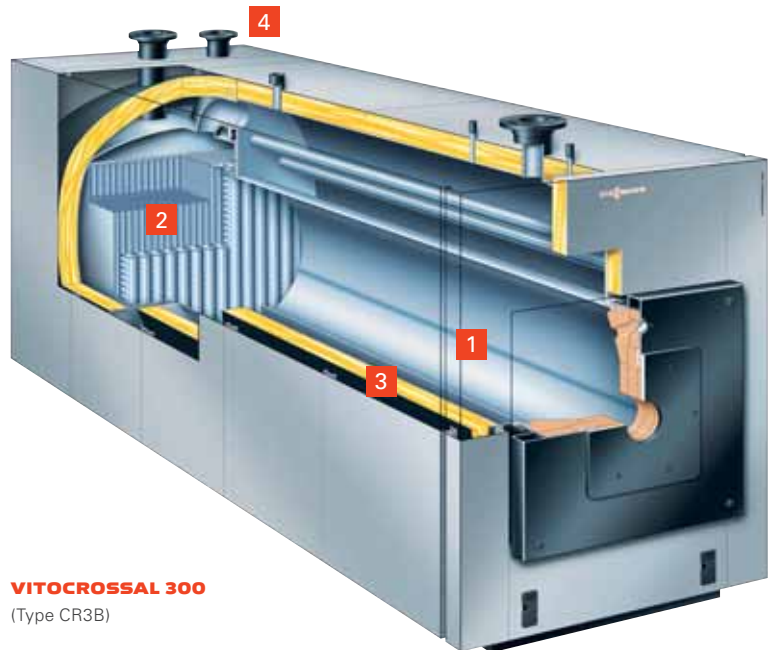

**VITOCROSSAL 300**  
(Type CR3B)

- 1 Stainless steel combustion chamber
- 2 Inox-Crossal heat exchanger
- 3 Highly effective thermal insulation
- 4 Two return connectors

#### BENEFITS AT A GLANCE

- + Standard seasonal efficiency [to DIN]: up to 98 % ( $H_g$ ) [gross cv]
- + High operational reliability and a long service life due to corrosion-resistant Inox-Crossal heat exchanger made from stainless steel
- + Available with ELCO or Weishaupt pressure-jet gas burner
- + Self-cleaning effect due to smooth stainless steel surface
- + Clean combustion through low combustion chamber loading and straight-through design
- + Two return connectors for hydraulic connection optimised for condensing technology
- + Easy to operate Vitotronic control unit with colour touchscreen
- + Vitosoft 300 service tool via integrated WiFi interface
- + Economical and reliable operation using Vitotronic control system with communication capability and Vitogate 300 (accessory) for integration into the building management system
- + Split design for easy handling
- + Vitocontrol control panel available on request



Vitocrossal 200 (type CIB) as a single boiler with a rated heating output of 80 to 318 kW

 | H<sub>2</sub> READY · 20%



The Vitocrossal 200 (type CIB) is also available as a twin boiler system in a single casing up to 636 kW.

The Vitocrossal 200 (type CIB) is a gas condensing unit for universal application with an output of 80 to 318 kilowatts; it is also available as a twin boiler system in a single casing with an output of 240 to 636 kilowatts. Its very good price/performance ratio makes this heating centre a particularly economical solution for both residential buildings and commercial enterprises.

It contains the enhanced Inox-Crossal heat exchanger and the proven, durable MatriX cylinder burner. Its modulation range down to 1:5 in conjunction with a large water content enables long burner runtimes and low energy consumption.

#### **Complete and compact**

The Vitocrossal 200, excluding casing, measures just 680 millimetres wide, making it ideal for modernisation projects in buildings where space may be limited. The heat generator can be ordered as a complete unit or with individual components delivered separately. As a complete unit, it is pre-wired, pre-assembled and checked at the factory. This significantly reduces the amount of work required at the installation site and therefore the time taken. Ground-level manoeuvring without lifting equipment is possible thanks to castors on the boiler and a ramp on the pallet.

#### **Lambda Pro Control combustion controller**

The integral Lambda Pro Control combustion controller automatically matches the burner to the type of natural gas (E, LL) and ensures consistently high and efficient combustion quality with low emissions. Hydrogen blends of up to 20 % by vol. are possible. The Vitocrossal 200 is suitable for open flue or room sealed operation.

**VITOCROSSAL 200**  
80 TO 318 KW  
AS A TWIN BOILER UP TO 636 KW

**Proven Vitotronic control unit**

The integral Vitotronic control unit enables rapid commissioning and easy operation. With Vitocom (optional), the boiler can also be conveniently controlled via app.

**Advanced condensing technology**

The heat exchanger has been specially designed to combine minimal dimensions with a low weight. At the same time, the stainless steel heat exchanger offers ideal conditions for utilising condensing technology: the smooth stainless steel heating surface allows the condensate that accumulates to simply run off. This results in a permanent self-cleaning effect – which ensures high efficiency in the long term and reduces the amount of maintenance required.



Corrosion-resistant Inox-Crossal heat exchanger made from stainless steel for high operational reliability and a long service life

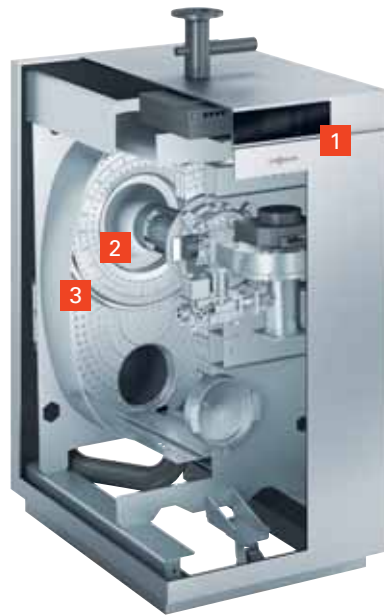

**VITOCROSSAL 200**  
(type CIB)

- 1** Vitotronic 200 boiler control unit
- 2** MatriX cylinder burner with Lambda Pro Control combustion controller
- 3** Enhanced Inox-Crossal heat exchanger

**BENEFITS AT A GLANCE**

- + Standard seasonal efficiency [to DIN]: up to 98 % (H<sub>g</sub>) [gross cv]
- + High operational reliability and a long service life due to corrosion-resistant Inox-Crossal heat exchanger made from stainless steel
- + MatriX cylinder burner with Lambda Pro Control for clean combustion through self-calibrating, gas-adaptive combustion control (NO<sub>x</sub> class 6)
- + Wide modulation range down to 1:5 and long burner runtimes without cycling for low-wear operation
- + For natural gas E and LL; futureproof due to hydrogen blends of up to 20 % by vol.
- + Easy to use Vitotronic control unit with plain text and graphic display, or convenient operation via app
- + Available as pre-wired, pre-assembled unit or as individual components
- + Easy to manoeuvre due to integrated castors
- + Compact dimensions, ideal where space is limited
- + Vitocontrol control panel available on request

## Low temperature oil/gas boilers with condensing heat exchanger



### VITORADIAL 300-T

#### Low temperature oil/gas boiler with condensing heat exchanger

Type VR3

Three-pass boiler with multi layered convection heating surfaces and Inox-Radial spiral heat exchanger installed downstream

101 / 129 / 157 / 201 / 263 / 335 / 425 / 545 kW

Standard seasonal efficiency [to DIN] for operation with fuel oil: up to 97 % (H<sub>3</sub>) [gross cv]

## Low temperature oil/gas boilers



### VITOPLEX 300

#### Low temperature oil/gas boiler

Type TX3A

Three-pass boiler with multi layered convection heating surfaces

405 / 500 / 620 / 780 / 1000 / 1250 / 1600 / 2000 kW

Standard seasonal efficiency [to DIN] for operation with fuel oil: up to 90 % (H<sub>3</sub>) [gross cv]



### VITOPLEX 200

#### Low temperature oil/gas boiler

Type SX2A

Three-pass boiler

440 / 560 / 700 / 900 / 1100 / 1300 / 1600 / 1950 kW

Standard seasonal efficiency [to DIN] for operation with fuel oil: up to 89 % (H<sub>3</sub>) [gross cv]



### VITOROND 200

#### Low temperature oil/gas boiler

Type VD2

Three-pass boiler in cast sectional design

440 / 500 / 560 / 630 / 700 / 780 / 860 / 950 kW

Standard seasonal efficiency [to DIN] for operation with fuel oil: up to 88 % (H<sub>3</sub>) [gross cv]



Scan the QR code for further information about low temperature oil/gas boilers.



## Flue gas/water heat exchangers

---



### **VITOTRANS 300**

#### **Stainless steel flue gas/water heat exchanger for gas and oil boilers utilising condensing technology**

in conjunction with

- Vitoplex 200 (700 to 1950 kW)
- Vitoplex 300 (620 to 2000 kW)

as a condensing unit for sealed unvented heating systems with permissible flow temperatures up to 110 °C to EN 12828

---



**Vitoradial 300-T**, 101 to 335 kW



**Vitoradial 300-T**, 425 to 545 kW

Its compact design and low build height make the Vitoradial 300-T the ideal choice for modernisation projects.

#### **Triplex pipes for 2.5 times larger heating surface**

The multi layered convection heating surfaces are comprised of telescopically arranged steel pipes pressed into each other for ideal heat transfer. The internal pipe surrounded by folded linear fins creates a heating surface 2.5 times greater than that of a smooth pipe. Due to the different gaps between the press points, the back area of the triplex pipes transfers less heat to the boiler water, as the combustion gases circulating here are no longer quite as hot. This keeps the surface temperature above the dew point, counteracting the formation of condensate and preventing corrosion damage.

#### **Utilising condensing technology with the Inox-Radial heat exchanger**

The downstream Inox-Radial heat exchanger enables highly efficient utilisation of the condensing effect, increasing the standard seasonal efficiency [to DIN] by eight percent to 97 percent (H<sub>2</sub>) [gross cv].

This principle ensures that combustion and condensation occur in physically separate locations and the combustion gases condense without leaving any residues behind. In practice, this means standard service intervals for cleaning the combustion chamber and low maintenance costs.

The Vitoradial 300-T is available up to an output of 545 kilowatts. The highly efficient Inox-Radial heat exchanger made from stainless steel prevents corrosion caused by acidic condensate.

#### **Convenient Vitotronic control unit**

The integral Vitotronic control unit with its large colour touchscreen is easy and intuitive to use. An assistant function helps with commissioning.

The boiler can be connected directly to Vitodata via a Vitocom interface. This enables the contractor to provide additional digital services to ensure reliable system operation. The Vitosoft 300 service tool communicates directly via WiFi.

Energy consumption can be clearly visualised with the control unit's energy cockpit.

The particularly compact three-pass boiler with multi layered convection heating surfaces and Inox-Radial spiral heat exchanger installed downstream is delivered inclusive of the easy to operate Vitotronic control unit with colour touchscreen.

**High efficiency with two-stage heat recovery**

The Vitoradial 300-T is the innovative combination of the Vitoplex 300 low temperature boiler with an Inox-Radial heat exchanger installed directly downstream, for the utilisation of condensing technology.

The proven multi layered convection heating surfaces, combined with the corrosion-resistant Inox-Radial heat exchanger, enable highly efficient two-stage heat recovery.

The Vitoradial 300-T is suitable for operation with all commercially available types of extra light (EL) fuel oil and natural gas.

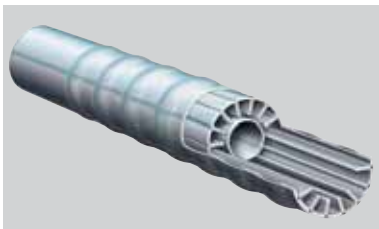

Multi layered convection heating surface



The Inox-Radial heat exchanger guarantees the highest levels of efficiency and a long service life.

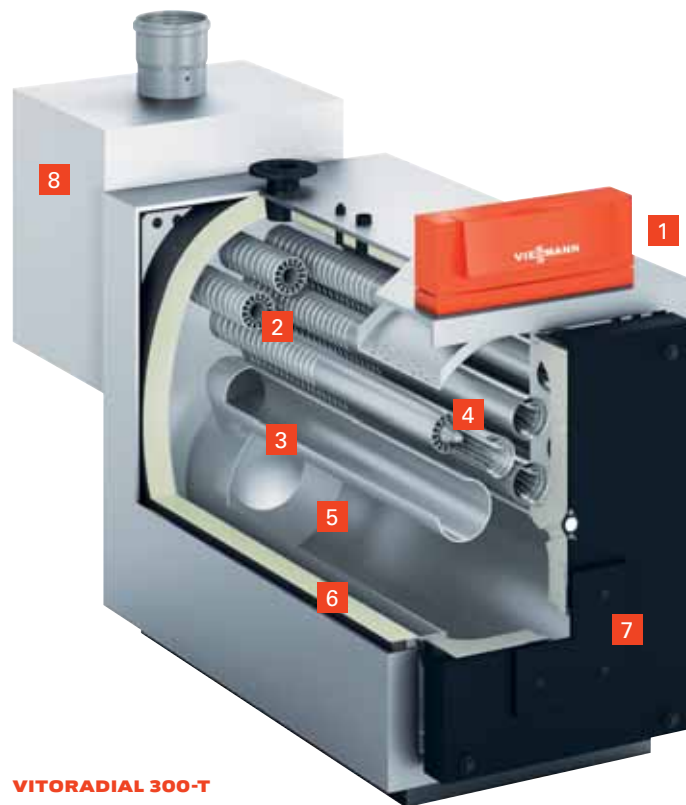

**VITORADIAL 300-T**

- 1 Vitotronic control unit with colour touchscreen
- 2 Hot gas flue (third pass; multi layered convection heating surface)
- 3 Hot gas flue (second pass)
- 4 Wide water galleries
- 5 Combustion chamber (first pass)
- 6 Highly effective thermal insulation
- 7 Boiler door with burner plate
- 8 Downstream Inox-Radial spiral heat exchanger

**BENEFITS AT A GLANCE**

- + Standard seasonal efficiency [to DIN] for operation with fuel oil: 97 % (H<sub>g</sub>) [gross cv]
- + Inox-Radial heat exchanger for the condensation of hot gases
- + Complete with heat exchanger pipework and pump, matched to the respective heating output of the boiler
- + Long burner runtimes and fewer switching intervals due to large water content for environmentally responsible operation
- + Compact design and low build height for easy manoeuvrability, ideal for heating system modernisation
- + Integral Therm-Control start-up system for simple hydraulic connection; no shunt pump or return temperature raising facility required
- + Easy to operate Vitotronic control unit with colour touchscreen
- + Integral WiFi for operation and service via app
- + Economical and reliable operation using Vitotronic control system with communication capability and Vitogate 300 (accessory) for integration into the building management system
- + Vitocontrol control panel available on request



Flue gas/water heat exchangers extract heat from the hot flue gases and use it to heat the water circuits, which increases the efficiency of the system.

**Vitotrans heat exchangers improve efficiency**

High fuel costs are of particular concern to users of medium sized and industrial/commercial boiler systems. The use of integral flue gas/water heat exchangers can significantly reduce running costs.

For larger systems or when retrofitting existing energy systems, the use of flue gas/water heat exchangers is therefore recommended.

**High efficiency of up to 101.5 percent**

A flue gas/water heat exchanger extracts the heat from the hot flue gases and uses it to heat the water circuits.

The integral, full-flow, non-condensing heat exchanger heats the heating water in the boiler return and therefore reduces the required combustion heating output of the boiler. This raises the boiler efficiency to over 95.6 percent.

The integral, partial-flow, condensing heat exchanger (30 percent of the boiler flow) transfers the heat from the flue gas to a secondary water circuit, which increases the efficiency to over 101.5 percent.



Integral flue gas/water heat exchanger



Downstream flue gas/water heat exchanger

**BENEFITS AT A GLANCE**

- + High efficiency for significant fuel savings and greater cost effectiveness of the system
- + High operational reliability and a long service life due to the use of corrosion-resistant stainless steel for the condensing heat exchangers
- + Flexible installation options and adaptation to individual local conditions thanks to downstream flue gas/water heat exchanger
- + Space saving due to compact design and integrated solution
- + Straightforward hydraulic connection (entire or partial water volume)
- + Matching neutralising systems

## CHP units

---



### VITOBLOC 300

#### Module NG 15

Outputs: 15 kW<sub>el</sub>, 38.3 kW<sub>th</sub>

Overall efficiency for operation with natural gas: 106.6 % (H<sub>i</sub>) [net cv]

#### Module NG 20

Outputs: 20 kW<sub>el</sub>, 46.5 kW<sub>th</sub>

Overall efficiency for operation with natural gas: 107.3 % (H<sub>i</sub>) [net cv]

Fuel: natural gas, LPG,

blends of 20 % hydrogen in natural gas

4-cylinder 4-stroke gas engine with 3-way catalytic converter

Water-cooled three-phase synchronous generator

Energy efficiency class: A+++

---



### VITOBLOC 200

#### Module EM-6/15

Outputs: 6 kW<sub>el</sub>, 14.9 kW<sub>th</sub>

Overall efficiency for operation with natural gas: 94 % (H<sub>i</sub>) [net cv]

#### Module EM-9/20

Outputs: 8.5 kW<sub>el</sub>, 20.1 kW<sub>th</sub>

Overall efficiency for operation with natural gas: 95 % (H<sub>i</sub>) [net cv]

Fuel: natural gas, LPG

3-cylinder 4-stroke gas engine with 3-way catalytic converter

Three-phase synchronous generator

Energy efficiency class: A++

---



### VITOBLOC 200

#### Module EM-50/81

Outputs: 50 kW<sub>el</sub>, 83 kW<sub>th</sub>

Overall efficiency: 90.3 % (H<sub>i</sub>) [net cv]

4-cylinder 4-stroke gas engine with 3-way catalytic converter

#### Module EM-70/115

Outputs: 70 kW<sub>el</sub>, 117 kW<sub>th</sub>

Overall efficiency: 90.7 % (H<sub>i</sub>) [net cv]

6-cylinder 4-stroke gas engine with 3-way catalytic converter

Fuel: natural gas

Three-phase synchronous generator

---



### VITOBLOC 200

#### Module EM-100/173

Outputs: 99 kW<sub>el</sub>, 173 kW<sub>th</sub>  
Overall efficiency: 93.8 % (H<sub>i</sub>) [net cv]

#### Module EM-134/202

Outputs: 134 kW<sub>el</sub>, 202 kW<sub>th</sub>  
Overall efficiency: 90.6 % (H<sub>i</sub>) [net cv]

#### Module EM-140/207

Outputs: 140 kW<sub>el</sub>, 209 kW<sub>th</sub>  
Overall efficiency: 90.9 % (H<sub>i</sub>) [net cv]

Fuel: natural gas  
6-cylinder 4-stroke gas engine with 3-way catalytic converter  
Three-phase synchronous generator

---



### VITOBLOC 200

#### Module EM-260/390

Outputs: 263 kW<sub>el</sub>, 390 kW<sub>th</sub>  
Overall efficiency: 94.2 % (H<sub>i</sub>) [net cv]

Fuel: natural gas  
12-cylinder 4-stroke gas engine with 3-way catalytic converter  
Three-phase synchronous generator  
As of Q4/2022: NG 260 in Vitographite (see image)

---



### VITOBLOC 200

#### Module EM-430/580

Outputs: 435 kW<sub>el</sub>, 581 + 33 kW<sub>th</sub>  
Overall efficiency: 89.7 % (H<sub>i</sub>) [net cv]

#### Module EM-530/660

Outputs: 530 kW<sub>el</sub>, 643 + 45 kW<sub>th</sub>  
Overall efficiency: 90.3 % (H<sub>i</sub>) [net cv]

Fuel: natural gas  
12-cylinder 4-stroke gas engine with oxidation catalytic converter  
Three-phase synchronous generator  
Modules also available as SCR and SCR-ready versions.

---



Scan the QR code for further information  
about CHP units.



#### Vitobloc 300

CHP units can run on natural gas containing up to 20 percent hydrogen.

 | H<sub>2</sub> READY · 20%



Clearly laid out and intuitive – the Vitobloc electronic platform

The new compact Vitobloc 300 NG 15 and NG 20 CHP units (NG = natural gas) differ in terms of their electrical and thermal outputs (15 kW<sub>el</sub>/38.3 kW<sub>th</sub>; 20 kW<sub>el</sub>/46.5 kW<sub>th</sub>).

#### Compact, quiet and supplied ready-to-connect

The Vitobloc 300 NG 15 and NG 20 are compact, ready-to-connect units with water-cooled synchronous generators for producing three-phase power and heating water. With their low operating noise of less than 50 dB(A) and small space requirement, they are suitable for new build and modernisation projects alike.

#### High availability due to long maintenance intervals

Maintenance is only required every 8000 hours run, which is usually equivalent to once a year.

#### Meets the connection conditions of power supply utilities

The equipment meets the demanding technical connection requirements of the power supply utilities. Thanks to the intelligent electronic platform, the power supply phase (cos phi) can be adjusted via the software. This eliminates the need for additional hardware modifications. The CHP units are equipped with integral grid and system protection as standard and are designed for mains substitution mode.

#### Integral condensing technology for high efficiency

The integral condensing technology enables overall efficiency of up to 107 percent. The resulting low exhaust gas temperature means that an inexpensive plastic exhaust system can be used. This simplifies the hydraulic connection and a return temperature raising facility is not required.



## VITOBLOC 300

15 kW<sub>EL</sub> / 38.3 kW<sub>TH</sub>

20 kW<sub>EL</sub> / 46.5 kW<sub>TH</sub>

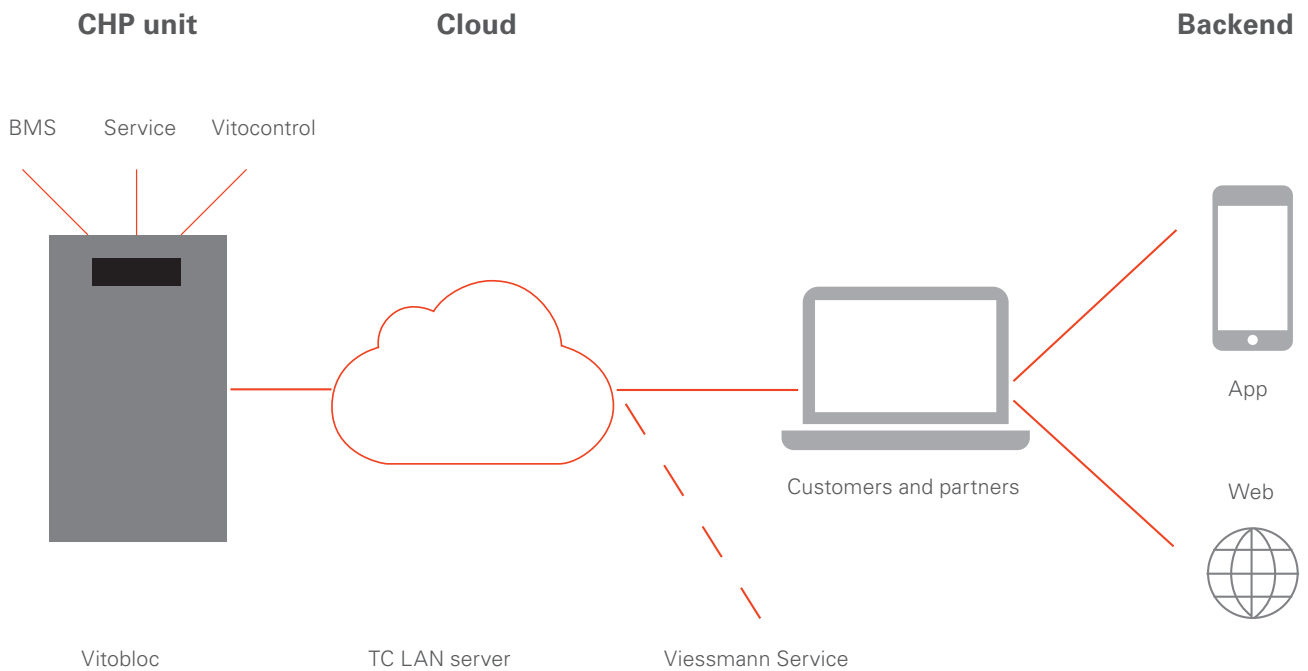

Vitobloc electronic platform

### Electronic platform

The core element of the electronic platform with the ViNCI module developed by Viessmann is a Linux-based industrial computer. This allows connection to innovative remote services and interfaces for communication in multi mode systems and building management systems. Cloud-based data management meets the highest security standards. Remote control and visualisation via the internet is of course possible using professional backend applications.

### Remote access via integral LAN interface

Useful conclusions can be drawn during operation about potential optimisation measures that can help to boost the efficiency of the system. Service calls can be planned in good time based on regular data analysis, thereby increasing response speeds. With remote access, on-site maintenance is no longer needed. This saves costs and increases the availability and operational reliability of the CHP unit.

### BENEFITS AT A GLANCE

- + Optimal design for apartment buildings, hotels, restaurants and small commercial enterprises
- + Suitable for natural gas, bio natural gas, LPG and blends of 20 % hydrogen
- + Complete, ready-to-connect, factory-tested compact units
- + Meet the strict technical connection conditions of power supply utilities
- + Tested to VDE AR-N 4105, with integral GS protection
- + Flexible setting of parameters to system-specific requirements
- + Integrated LAN interface for remote access via internet
- + Smooth running 4-cylinder engines
- + Low upkeep costs thanks to long maintenance intervals of up to 8000 hours run
- + Attractive state subsidies
- + Integral heating water pump for charging a heating water buffer cylinder
- + Flexible hydraulic connection and very high flow temperatures



Vitobloc CHP units for generating power and heat

With Viessmann, you can rely on over 25 years of experience in the design, production and installation of efficient, gas-powered CHP systems.

The company offers combined heat and power units for individual solutions in a wide output range – for every demand and every application. The units impress with their high quality and good system integration. This means that users can be sure that the investment will pay off.

#### Simply more efficient by design

CHP units are at the heart of an efficient power and heat supply. However, they can only develop their full potential in a system with perfectly combined components. As a supplier of complete systems, Viessmann offers the entire system technology from a single source: from connection to the water and power supply, through integration into the heating circuit, to exhaust gas routing.

**High cost effectiveness**

CHP units from Viessmann have an impressive level of efficiency. The units are particularly easy to maintain with intervals of up to 8000 hours run. Thanks to integral condensing technology, they achieve overall efficiency of up to 107 percent. Vitobloc 200 and Vitobloc 300 are up to 50 percent electrically modulated and can be run with both heat-led and power-led operation.

Special benefits result from the extensive range of technical equipment, including flexible connections for gas, exhaust gas, extract air and heating water, as well as the standard silencer hood for significantly reduced operating noise (part of the standard delivery for units up to 140 kW<sub>el</sub>).

**BENEFITS AT A GLANCE**

- + Complete energy systems for the generation of heat and power – from concept development to matching services
- + Broad application spectrum in the low and medium output range for local authorities, commercial enterprises and industry
- + Many years of experience with more than 5000 installed systems
- + Uncomplicated engineering and installation
- + Power-led or heat-led operation
- + Integral hydraulic system separation
- + Mains substitution mode as standard
- + Connection requirements of grid operators are met as standard
- + Long maintenance intervals of up to 8000 hours run
- + Quality inspection at the factory
- + Proven remote monitoring and automation concepts
- + Comprehensive service concepts



ETA Heiztechnik GmbH, 4716 Hofkirchen an der Trattnach, Austria

## Cooperation between ETA and Viessmann

### ETA Heiztechnik GmbH

ETA Heiztechnik GmbH, an Austrian company, has been developing and building biomass boilers since 1998.

Patented technology and state of the art control systems offer maximum efficiency and convenient operation. More than 250 employees produce up to 20,000 boilers per year.

With an export quota of more than 80 percent, ETA is a leading manufacturer.

Three ETA boilers – the ePE-K, eHack and Hack VR – are now available in the Viessmann product range for operation with pellets and woodchips in the output range from 100 to 500 kilowatts.



### ETA ePE-K

Pellet boiler for businesses and residential buildings  
Rated heating output: 100 to 240 kW



### ETA eHACK

Woodchip boiler for agricultural applications and businesses  
Rated heating output: 100 to 240 kW



### ETA Hack VR

Woodchip boiler for industry, commerce and heating networks  
Rated heating output: 250 to 500 kW



ETA ePE-K

100, 110, 120, 130,  
140, 150, 160, 170,  
180, 200, 220, 240 kW



ETA eHACK

100, 110, 120, 130,  
140, 150, 160, 170 kW



ETA eHACK

180, 200, 220 and 240 kW



ETA HACK VR

250, 333, 350, 463 and 500 kW



ETA stratification buffer

ETA ECO cylinder 500  
SP 600, 825, 1000, 1100, 1650 and 2200 litres,  
Solar SPS 600, 825, 1000, 1100, 1650 and 2200 litres

3000, 4000 and 5000 litres



ETA hydraulic modules

Freshwater modules, solar stratification charging module,  
system separation module, mixer circuit module, transfer module,  
transfer station



Vitoligno 300-C

Pellet boiler  
Fully automatic biomass boiler for pellets  
60 / 70 / 80 / 99 / 101 kW  
Efficiency: up to 96 %



Scan the QR code for further information about the  
Viessmann biomass range.

## Large heat pumps



### VITOCAL 350-G PRO

#### Two and three-stage brine/water heat pump

Electrically driven for central heating/cooling and DHW heating in mono mode or dual mode heating systems  
 With electronic soft starter  
 27.3 / 33.6 / 57.1 / 76.2 / 93.5 / 114.3 / 131.8 / 156 / 171.6 / 197.9 kW  
 Max. flow temperature: up to 73 °C



### VITOCAL 300-G PRO

#### Two-stage brine/water heat pump

Electrically driven for central heating/cooling and DHW heating in mono mode or dual mode heating systems  
 84.9 / 108.7 / 135.3 / 174.9 / 222.2 kW  
 Max. flow temperature: up to 60 °C



### VITOCAL 200-G PRO

#### Two-stage brine/water heat pump

Electrically driven for central heating/cooling and DHW heating in mono mode or dual mode heating systems  
 With electronic soft starter  
 75.4 / 101 kW  
 Max. flow temperature: up to 60 °C



### VITOCAL 350-HT PRO

#### Two and three-stage brine/water heat pump

Electrically driven for central heating and DHW heating in mono mode heating systems  
 With electronic soft starter  
 56 / 71.5 / 86 / 98 / 119.5 / 126.5 / 147 kW  
 Max. flow temperature: up to 90 °C  
 Max. evaporator inlet temperature up to 45 °C



Scan the QR code for further information about large heat pumps.

## Brine/water and water/water heat pumps

---



**VITOCAL 300-G**  
**VITOCAL 350-G**

### Single and two-stage heat pumps

Electrically driven for room heating and DHW heating in mono mode or dual mode heating systems, without integral circulation pump

- Brine/water heat pumps  
Heating outputs: 20.5 to 85.6 kW
- Water/water heat pumps  
Heating outputs: 25.4 to 117.8 kW

**Vitocal 300-G:** Max. flow temperature: up to 60 °C

**Vitocal 350-G:** Max. flow temperature: up to 68 °C

---

## Air source heat pumps

---



**VITOCAL 300-A**

### Two-stage air source heat pump

Electrically driven for central heating and DHW heating, for outdoor installation

13.2 to 55.8 kW

Max. flow temperature: up to 64 °C

---

## Ice energy stores

---



**Ice energy stores**

### Ice storage tanks for operation with brine/water heat pumps in large scale systems

Output sizes on request

---



Scan the QR code for further information about ice energy stores.



Viessmann heat pumps are designed for larger residential complexes and commercial operations.

Natural heat is an advanced and cost effective alternative to fossil fuels. It is available free of charge and offers independence from oil and gas.

Heat pumps offer ideal conditions for reducing heating bills and achieving environmentally responsible heat generation. After all, the energy a heat pump uses is free and available in unlimited supply from the environment.

With a heat pump, up to 80 percent of the total energy demand is taken from nature, in a highly effective and environmentally responsible manner. Only 20 to 30 percent electrical energy needs to be invested.

The principle is as simple as it is ingenious: the solar energy stored in the ambient air, ground and groundwater is used to efficiently heat domestic hot water and heating water.

#### **Added value through cooling function and dual mode systems**

Heat pumps are also available with high outputs and are designed to meet the energy demand of larger residential complexes and commercial operations. The operating mode can be "reversed", allowing them to be used for cooling the interior in summer too.

The idea that a heat pump only suits new build projects is outdated. On the contrary, if an existing conventional oil or gas heating system is modernised or supplemented with a heat pump (to form a dual mode system), reductions in heating costs can be achieved and emissions lowered at the same time. Independence from fossil fuels actively contributes to reducing CO<sub>2</sub> emissions and protecting the climate.

#### **Recovering environmental energy**

Various natural sources are suited to heat recovery using a heat pump:

- Water – such as groundwater, river or lake water, waste water
- Ground – via geothermal probes, geothermal collectors, energy piles
- Air
- Waste heat

Not all of these heat sources can be used in all locations. It is therefore necessary to consult the relevant authorities before making a decision, and discuss the technical options with Viessmann.



Brine/water heat pumps utilise the heat stored in the ground. It is both free and readily available.

Geothermal probes offer a durable and maintenance-free way to tap into this heat source. In conjunction with heat pumps, they deliver heating energy, and are also the ideal heat exchanger for natural cooling. In both cases, Viessmann brine/water heat pumps utilise the free heat stored in the ground.

**Perfect size for all kinds of heat transfer**

Viessmann's heat pump portfolio is tailored to the needs of its customers. Flow temperatures of 35 to 40 °C are economical and cost effective for area heating systems. The series-produced large heat pumps feature efficient output modulation or multi stage refrigerant circuits, depending on their output. Ventilation systems work with flow temperatures of up to 55 °C. If, for technical reasons, temperatures of up to 70 °C are required, heat pumps from the Vitocal 350-G Pro series offer the perfect solution.

**Convenient DHW heating**

Frequently, DHW temperatures above 60 °C are required. However, particularly for large heat pumps, the performance proportion for DHW heating is low. In such cases, multi stage heat pumps or hot gas decoupling are a convenient solution. The use of special safety heat exchangers guarantees global potable water requirements are maintained.

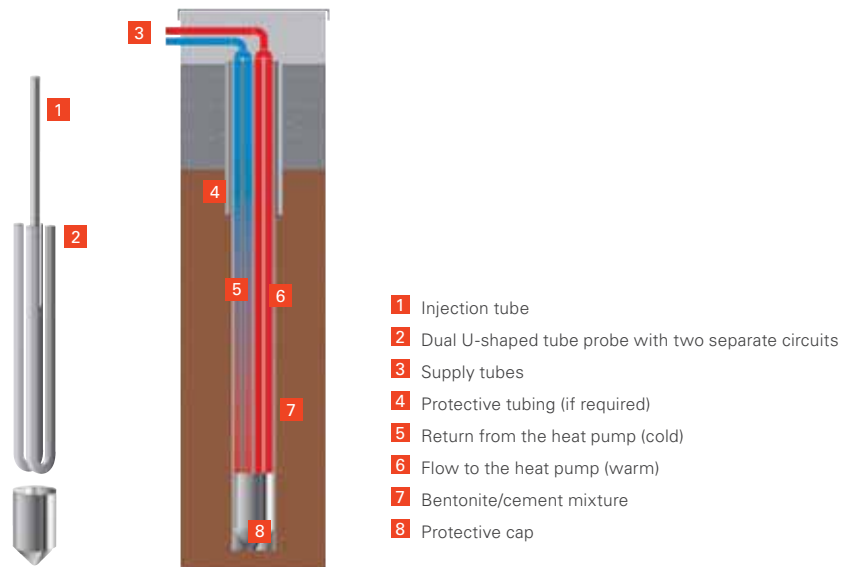

**Geothermal probe**

The geothermal probe is composed of two U-shaped tubes. In the centre of this tube bundle there is an injection tube through which a bentonite/cement mixture is pressed after the probe has been installed in situ. The drilled hole is filled from bottom to top. This guarantees the entire probe is connected with the surrounding earth, seals off any water-carrying layers from one another and protects the probe.



Geothermal probe manifold



Water, as the storage medium, is harmless to the environment and can be used anywhere.

The ice energy store system operates on a simple principle: energy from the sun, air and ground is fed at a low temperature into an underground tank – the ice store.

A heat pump extracts the heat from the ice store and compresses it to a higher flow temperature for heating the building.

The system ices up due to the extraction of heat from the ice store. Crystallisation energy is released in the phase transition from 0 °C cold water to 0 °C cold ice. This supplies as much energy as is required to heat water from 0 °C to 80 °C – and vice versa. Through the systematic interplay of heat extraction and regeneration, the freezing process can be repeated within a heating season several times, whereby the crystallisation energy available is virtually unlimited.

### Free cooling in the summer

In the summer months, the ice energy store can also be used to cool buildings naturally. After the water in the store has iced up at the end of the heating season, cooling energy is drawn from the ice store in the summer.

The low outdoor temperatures on summer nights can also be used to cool the water in the store or in the heating circuit itself via solar air absorbers. This allows the period of natural cooling with free cooling energy to be significantly extended.

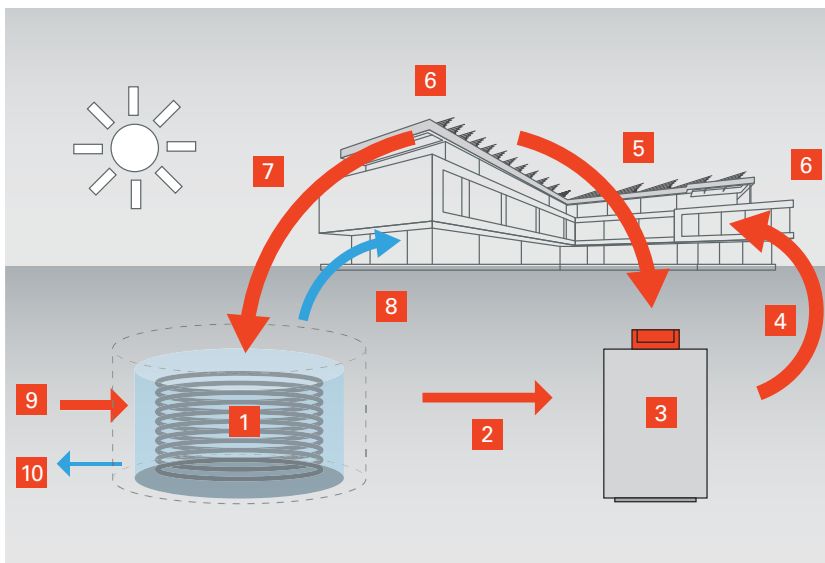

Illustrative example of an ice energy storage system

- 1 Ice energy store
- 2 Energy from ice store
- 3 Heat pump and control unit
- 4 Total energy from heat pump to building
- 5 Energy from direct collector operation
- 6 Solar air absorbers (collectors)
- 7 Energy from collectors
- 8 Natural cooling
- 9 Heat recovery from the ground
- 10 Heat loss to the ground

## Everything from a single source

### 1. Demand calculation

The use of a building simulation tool provides information on the individual heating or cooling demand. On this basis, the overall energy concept is drawn up, taking into account all the individual circumstances.

### 2. Component design

This is followed by designing the energy source and the provision of heating/cooling. All system components are sized and matched to provide the best possible coverage of the needs identified.

### 3. On-site implementation

All components are delivered and installed on schedule. If required, Viessmann can provide all the services related to cooling and heating up to the point where the pipework connects to the heating water buffer cylinder.

### 4. Assistance with commissioning

Viessmann offers comprehensive services from design right through to commissioning. This ensures efficient, reliable system operation.

### 5. Energy source management

As part of energy source management, system data is continuously collected via remote monitoring and system operation is optimised accordingly. This results in continuously low running costs.



The crystallisation processes in the ice store can be visualised via camera transmission.

## BENEFITS AT A GLANCE

- + Simplified utilisation of several heat sources with comparatively low investment costs
- + Outdoor air, solar radiation and the ground are used simultaneously as heat sources
- + High efficiency on account of up to three energy sources
- + Store for primary energy as an efficient, attractively priced alternative to geothermal probes and geothermal collectors that requires no permits
- + No drilling necessary
- + Heat recovery exclusively from renewable energy sources
- + Affordable and environmentally responsible heating and cooling
- + Intelligent energy source management for best possible utilisation of the ice store, solar air absorbers and heat pump
- + System is easy to maintain and service
- + All components and services from a single source
- + Standardised processes for high cost certainty, short installation times and adherence to schedules

## Steam boilers\* | H<sub>2</sub> READY · 100%



### VITOMAX HS

#### High pressure steam boiler

Outputs: 0.5 to 31.5 t/h  
 Permissible operating pressure: 6 to 25 bar  
 (higher pressures on request)  
 Also available as low NO<sub>x</sub> version  
 (gas < 70 mg/m<sup>3</sup> / oil < 150 mg/m<sup>3</sup>)  
 With integral economiser



### VITOPLEX LS

#### Low pressure steam boiler

Outputs: 0.26 to 2.2 t/h  
 Permissible operating pressure: 0.5 or 1.0 bar

## Hot water boilers\* | H<sub>2</sub> READY · 100%



### VITOMAX HW

#### High pressure hot water boiler

Outputs: 0.35 to 21.0 MW  
 Permissible flow temperature: > 110 °C  
 Permissible operating pressure: 6 to 20 bar  
 Also available as low NO<sub>x</sub> version  
 (gas < 70 mg/m<sup>3</sup> / oil < 150 mg/m<sup>3</sup>)  
 With integral conventional/condensing heat exchanger (up to 9.0 MW)



### VITOMAX LW

#### Low pressure hot water boiler

Outputs: 0.7 to 21.5 MW  
 Permissible flow temperature: up to 110 °C  
 Permissible operating pressure: 6 to 16 bar  
 Also available as low NO<sub>x</sub> version  
 (gas < 70 mg/m<sup>3</sup> / oil < 150 mg/m<sup>3</sup>)  
 With integral conventional/condensing heat exchanger (up to 9.0 MW)



Scan the QR code for further information  
 about steam and hot water boilers.

## Electric boilers/electric hybrid boilers\*

 | H<sub>2</sub> READY · 100%



**VITOMAX HS-E**  
(steam)

**VITOMAX HW-E/LW-E**  
(hot water)

### Electric boiler for steam or hot water generation

Outputs: 0.5 to 5.0 t/h/0.45 to 4.5 MW  
Permissible operating pressure: 6 to 25 bar  
(higher outputs and pressures on request)



**VITOMAX HS-EH**  
(steam)

**VITOMAX HW-EH/LW-EH**  
(hot water)

### Electric hybrid boiler for steam or hot water generation

Fired boiler with additional electricity use  
Outputs: 1.2 to 8.4 t/h/~ 0.8 to 5.6 MW  
Combustion to electricity ratio: ~ 4:1  
(higher outputs and pressures on request)

## Waste heat boilers/waste heat hybrid boilers\*

 | H<sub>2</sub> READY · 100%



**VITOMAX RS-A**  
(steam)

**VITOMAX RW-A**  
(hot water)

### Waste heat boiler for steam or hot water generation

100 % waste heat utilisation



**VITOMAX RS-AH**  
(steam)

**VITOMAX RW-AH**  
(hot water)

### Waste heat hybrid boiler for steam or hot water generation

Boiler with burner and additional waste heat utilisation

\* Vitomax shell boilers are already designed for operation with 100 % hydrogen and therefore offer very good security of planning. Biogenic fuels and LPG round off their wide range of applications.



**Vitomax LW** hot water boilers

Heating centres for large residential and office buildings as well as commercial enterprises must meet special requirements. Not only is clean, energy saving provision of heat essential, but also high operational reliability and system availability. Viessmann's integrated range of solutions therefore includes hot water boilers that are designed and equipped to meet individual customer requirements in a wide range of applications.

Furthermore, businesses ranging from small production companies up to international industrial giants need steam for their manufacturing processes. Here, too, in addition to the clean and energy saving provision of saturated steam, a high level of operational reliability and system availability form the basis for sustainable and efficient operation. For this purpose, Viessmann offers steam boilers and matched system components as complete solutions that are individually tailored to customer requirements.



**Vitomax HS** steam boiler (left) with TWA-V total thermal deaeration system (right)

The Vitomax boiler system can be controlled easily and conveniently using the pre-configured control systems Vitocontrol Basic and Vitocontrol Basic with extended options. Integral controls for burners, pumps and valves ensure safe and trouble-free boiler operation.

Up to four boilers can be controlled simultaneously with the integral cascade function of the Vitocontrol Basic. The system can be easily integrated into an existing control system by connecting it to higher-level building management technology. This also includes the possibility of remote monitoring and troubleshooting at any time from any location.

Vitocontrol Comfort really comes into its own in respect of system extensions. Whether it is a question of controlling the required operating parameters of the boiler, burner, water treatment system, valves, drives, flue gas components or ventilation dampers in the boiler house: the intuitive operating philosophy and password-protected access levels make controlling the system a very safe and straightforward matter.

The Energy Monitoring module offers full transparency of electricity and energy data. Viessmann thereby meets the statutory requirements for continuous improvement of the energy balance in production in accordance with EN ISO 50001.

In addition, the Predictive Maintenance module identifies inefficiencies and possible signs of wear at an early stage, which can then be corrected quickly. This allows maintenance work to be planned for optimum times, reducing downtimes to a minimum.



Vitocontrol Comfort



Vitocontrol Comfort



Energy Monitoring

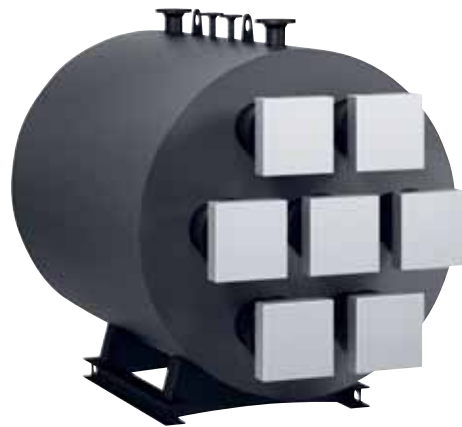

Predictive Maintenance (example showing switch counters)

100 % electric – **Vitamax HS-E** steam boiler**Vitamax HW-E** hot water boiler

 | H<sub>2</sub> READY · 100%

Reducing greenhouse gases and moving from fossil fuels to environmentally responsible solutions is also an important topic in the application area of industrial/commercial boilers. Vitamax low NO<sub>x</sub> boilers are perfectly engineered for low emission combustion processes. They can meet even the most demanding requirements of less than 30 mg/m<sup>3</sup> NO<sub>x</sub>. But it is not only the Vitamax low NO<sub>x</sub> versions that make a significant contribution to reducing emission values. Fully electric and hybrid electric boilers offer particular advantages as well.

#### **Hybrid or 100 percent electric**

Vitamax boilers are designed for either fully electric operation or hybrid operation with a combination of a pressure-jet burner and electric heating cartridges. Operation with electricity makes it possible to benefit from low tariffs at certain times, or to make good use of self-generated electricity. This also reduces CO<sub>2</sub> emissions, since fully electric boilers produce zero (operational/local) emissions. In addition, Viessmann offers special, project-specific solutions for the electrical superheating of saturated steam or deaeration for water treatment. Boiler models that make use of waste heat are also becoming increasingly important.





100 % waste heat utilisation – Vitomax RS steam boiler

**Energy recovery from waste heat**

Waste heat boilers utilise hot flue gases or exhaust air from combustion processes to heat water or generate saturated steam. The industrial/commercial boilers come in two versions: waste heat only or hybrid. Waste heat boilers without auxiliary combustion use 100 percent of the flue gases/exhaust air to generate saturated steam or hot water. The hybrid waste heat version, on the other hand, has a boiler with a burner plus additional passes for utilising waste heat. Due to economic considerations or legal requirements, these boilers are often used in combination with gas turbines or CHP units. Particularly in the context of rising energy costs, waste heat boilers are seen as an advantageous alternative, as they make efficient and economically viable use of the otherwise unused waste heat from combustion processes.

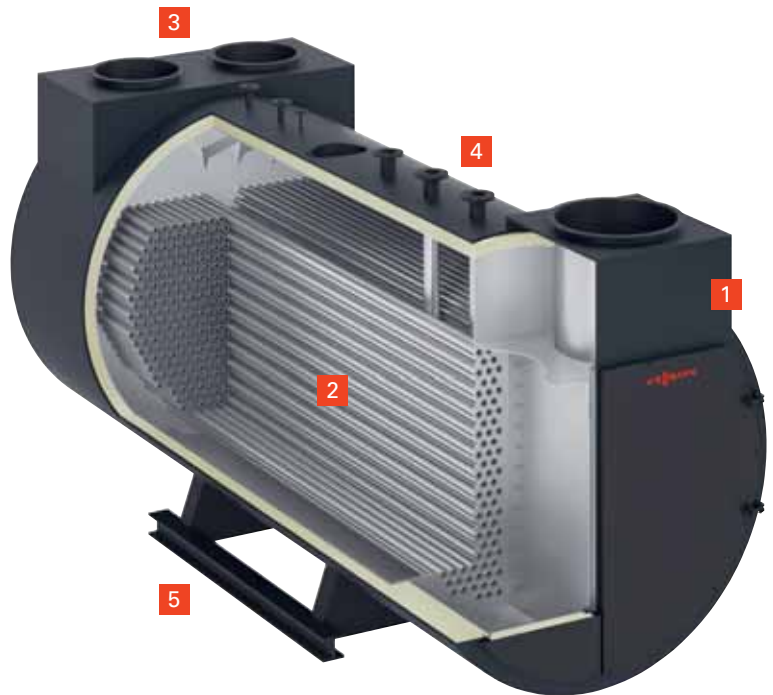

**VITOMAX RS**

- 1 Connection for up to 2 different waste heat sources
- 2 Smoke tube bundle for heat transfer
- 3 Flue gas outlets of waste heat sources/connection options for the flue gas path
- 4 Variable connector configuration according to customer requirements
- 5 Boiler support with longitudinal I-beams for better load distribution and ability to connect components, pipework, etc.



Steam boiler with superheater module for higher steam demands



Steam boiler with control platform for convenient and safe access to fittings and inspection ports on the top of the boiler

#### **Boiler control platforms for all scenarios**

Depending on customer requirements, a choice can be made between a side platform (to the right or left of the boiler crown) and a full-surface control platform (across the entire boiler width). Safe and convenient access to fittings and inspection ports on the top of the boiler is therefore guaranteed.

#### **Wear-resistant burner entry point**

No concrete is needed for the burner entry point. This makes it wear and maintenance-free, so there is no need to replace it during the service life of the Vitomax boiler. Downtimes required for drying out the concrete refractory lining following repair work (due to wear of the lining) are completely eliminated. This design principle results in increased operational reliability and significantly lower running costs.

Numerous design features facilitate the installation, operation and service of these powerful steam and hot water boilers: longitudinal beams on the boiler base provide optimum pulling and lifting options for ease of handling. Better load distribution over the longitudinal beams allows for a less expensive foundation, which contributes to cost savings. A boiler base version with additional reinforcements is available for earthquake zones.

#### **Turbulators as an equivalent heating surface**

Higher efficiency despite a smaller nominal heating surface is achieved with turbulators. They swirl the flue gases to ensure better heat transfer inside the smoke tubes. The length of the turbulators is subject to the residual pressure of the burner used and further raises efficiency. Fuel consumption and running costs are additionally reduced.

#### **Higher efficiency with heat exchangers**

Integral or separate heat exchanger solutions increase the system efficiency. They contribute to lower fuel consumption and reduce running costs considerably. The heat exchangers can be flexibly adapted to any system.

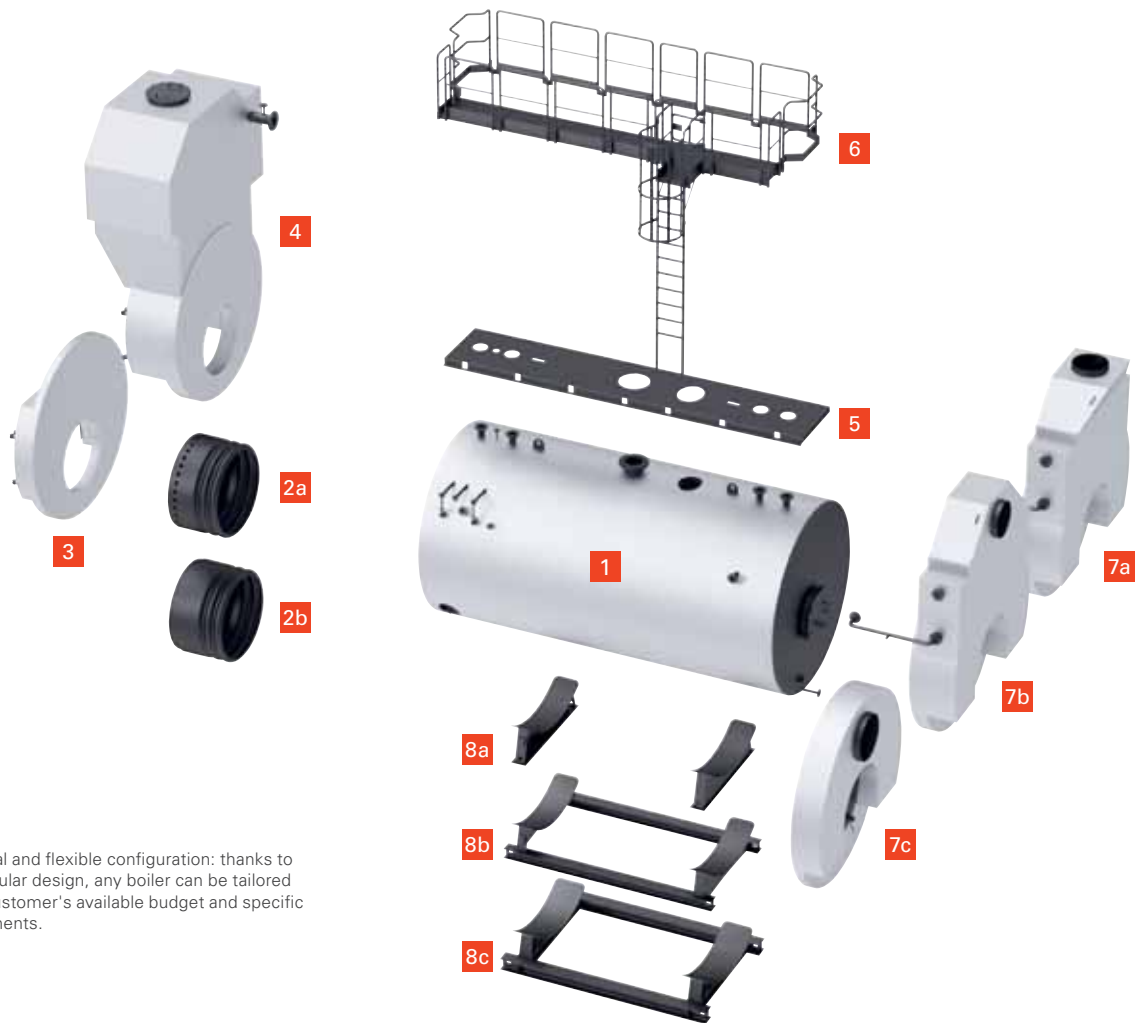

Individual and flexible configuration: thanks to the modular design, any boiler can be tailored to the customer's available budget and specific requirements.

- 1** Vitomax steam boiler
- 2a** Wear and maintenance-free burner entry point
- 2b** Concrete burner entry point
- 3** Front reversing chamber with boiler doors
- 4** Front reversing chamber with mounted superheater module
- 5** Accessible area of control platform
- 6** Guardrail and ladder (example with back guard)
- 7a** Flue gas collector with ECO and flue gas outlet to the top
- 7b** Flue gas collector with ECO and flue gas outlet to the rear (or to the right/left if required)
- 7c** Flue gas collector with round flue gas outlet
- 8a** Boiler support as cross plates
- 8b** Boiler support as cross plates with longitudinal I-beams
- 8c** Boiler support as full I-beam version



Scan the QR code for further information about the Vitomax Configurator.



Vitocontrol 100-M is a powerful, modular system controller with an intuitive graphic user interface.

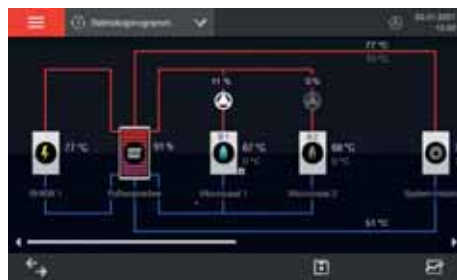

Clearly laid out system scheme showing relevant system data with direct access to heat generators, DHW cylinders and consumers, as well as access to the fault message control centre and trend data.

### Vitocontrol 100-M

The Vitocontrol 100-M is a higher-level control unit for multi mode, multi boiler systems in a control panel design. The control unit supports a large number of predefined system examples and combines all functionalities required for efficient control of the heating system in one central location.

The standardised system examples consist, amongst other things, of different combinations of base load generators such as CHP units, heat pumps or pellet boilers, as well as peak load generators such as oil or gas boilers, and heat consumers in multiple heating circuits or a DHW cylinder. Accessories are available to connect the Vitocontrol 100-M to the internet. This opens up the possibility of remote control and remote diagnosis.

### Product features

- Compact, wall mounted casing with 7 inch colour touchscreen for convenient parameter setting and system optimisation
- Graphical representation of the system scheme with actual values and status displays
- Buffer management and cascade control for base and peak load generators
- Speed control of boiler circuit pumps for peak load generators and other circulation pumps
- Weather-compensated or constant temperature mode
- Central point for messages from the entire heating system
- Heating circuit and DHW cylinder control
- Connection of up to 12 additional heating circuits with mixer through Vitotronic 200-H
- Integration into the building management system via Modbus TCP or BACnet IP as well as connection of M-Bus meters (possible with accessories)



Messages from the connected heat generators and external pumps are displayed in plain text and as a list with the associated fault codes.



The system characteristics can be tracked over a period of up to 4 weeks directly on the system controller. With the aid of these values, the energy system can be optimised and its efficiency and cost effectiveness enhanced.

**Vitocontrol 200-M**

The Vitocontrol 200-M is a central control unit for the convenient operation of multi mode energy systems with various combinations of heat generators, as well as cooling, ventilation, solar and electricity components.

**Product features**

- Customer-specific solutions based on a modular system
- Can be flexibly extended with new functions and process applications
- Floorstanding or wall mounted casing versions
- With either 9, 12 or 15" colour touchscreen
- Convenient operation and individual display of the system configuration and operating data
- User and access management
- Connection to ViScada for web-based system visualisation

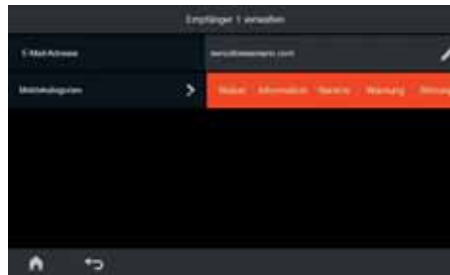

System messages can be sent by email to up to three stored recipients. It is possible to define on an individual basis which message categories are to be sent to each recipient.

**BENEFITS AT A GLANCE**

- + Easy realisation of mono or multi mode systems based on system examples
- + Rapid commissioning via configuration file and commissioning assistant for standardised applications
- + Compact wall mounted enclosure (width x height x depth: 600 x 400 x 210 mm) for straightforward installation – even where space is tight
- + Convenient parameter setting and system optimisation via the colour touchscreen
- + Integration of further heating circuits and adjacent buildings with the Vitotronic 200-H
- + Connection of up to 5 M-Bus meters (via accessories)
- + Compatible with standard BMS interfaces such as BACnet & Modbus (via accessories) and hardware contacts for external set value specification
- + System operation also possible without consumer circuits
- + Virtual, weather-compensated heating circuit for generating the system set value or setting a constant system set value



**ViScada** – innovative web solution for the comprehensive transparent visualisation of multi mode energy systems

The intelligent management of energy flows between generators and consumers is key to the efficient use of different energy sources. The innovative ViScada (Viessmann Supervisory Control and Data Acquisition) web solution gives system users and trade partners a comprehensive and transparent visualisation of multiple multi mode energy systems, all the way down to individual system components.

### Important information in real time

A dashboard provides the user with all the most important information about the system status in real time. This includes values relevant to both generation and consumption. The system characteristics can therefore be evaluated at a glance and system parameters can be adjusted immediately if necessary. Fault messages can be sent by email or SMS to defined recipient groups. At the same time, the messages are automatically displayed on the interface and documented. This has the benefit of much shorter response times if a fault occurs.

### Archiving simplifies data analysis

Archiving measured values makes it possible to analyse the system characteristics at any time and to optimise individual parameters on an ongoing basis. In addition to ready-made standard templates in the form of line charts or heat maps, individual templates can also be configured via filters. The templates can be created for the entire system or for specific generators. Reports are automatically generated using the archived data and sent to the users by email.



Vitocontrol local user interface



**Vitocontrol 200-M**  
multi mode system controller

There is a choice of different report templates which the user can subscribe to individually. The reports are archived and can be retrieved later at any time.

**Much higher availability of the energy system**

In order to use ViScada, it is necessary to have the Vitocontrol 200-M or Vitocontrol 100-M system controller. With a flexible licence model, the digital service can cover all application areas of the multi mode Vitocontrol control system. A gateway acquires the data from the local system controller and transmits it to the Viessmann Cloud in encrypted form. This enables remote monitoring of systems at any time from any location, which significantly increases the availability of energy systems.

**NEW: Available in the 2022 version**

- Standard visualisation of ice energy store systems and PEWO heat interface units
- Extension of automatic reporting to the monitoring team with regard to a possible shortfall in heat supply or a detrimental operating mode

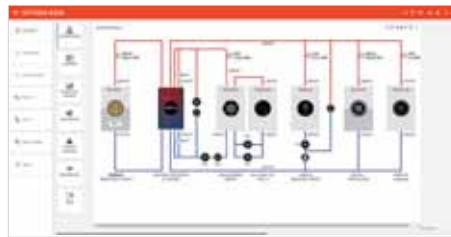

ViScada visualises multi mode systems. Their performance can be evaluated at a glance and set values adjusted as required.



Archiving measured values and displaying user defined trends make it possible to analyse the system characteristics at any time and to optimise individual parameters on an ongoing basis.

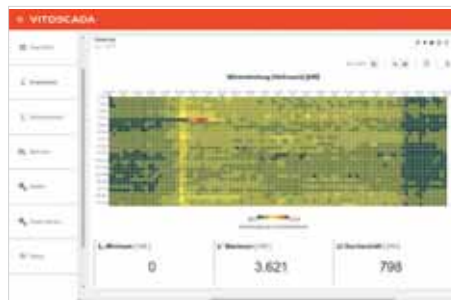

Display of heating output on the consumption side as a heat map

Licence	Description
<b>ViScada 100-M standard</b>	<ul style="list-style-type: none"> <li>— Matched to Vitocontrol 100-M for an energy system with Viessmann standard scheme and</li> <li>— a maximum of 4 heat generators</li> <li>— a maximum of 4 heating circuits</li> <li>— a maximum of 120 data points</li> </ul>
<b>ViScada 200-M standard</b>	<ul style="list-style-type: none"> <li>— Matched to Vitocontrol 200-M for a project-specific system with a maximum of 400 data points</li> </ul>
<b>ViScada 200-M individual</b>	<ul style="list-style-type: none"> <li>— Matched to Vitocontrol 200-M for a project-specific system with more than 400 data points</li> </ul>

**BENEFITS AT A GLANCE**

- + Map view and markers of different systems
- + Hydraulic scheme at a glance
- + Detailed user-dependent view
- + Message list with option to forward messages by SMS or email
- + Documentation of messages including escalation hierarchy
- + Digital operating log
- + Long term archiving
- + User defined trend display
- + Different display formats such as curves or heatmap charts
- + Access and rights management
- + Key date selection
- + Reporting with ISO 50001 certification

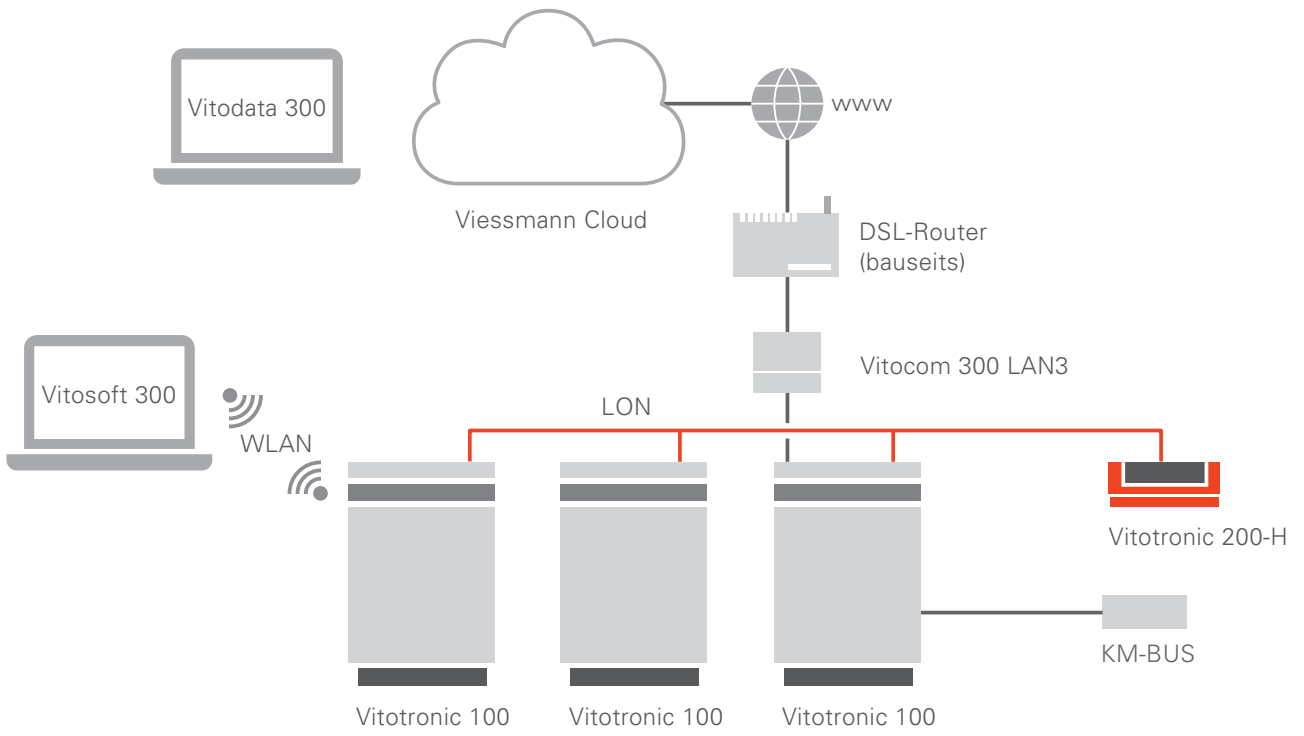

Vitocom and Vitodata are designed for applications of heat supply utilities, contractors and municipal services.



Viessmann offers intelligent solutions for data communication that are optimally matched to the requirements of system users and power supply utilities.

#### **Intelligent solutions for data communication**

Vitocom 300 internet data communication in combination with Vitodata 300 is the professional monitoring tool for larger residential properties or commercial buildings – optimally designed for applications of heat supply utilities, contractors and municipal services. Vitocom 300/ Vitodata 300 ensures reliable optimisation, maintenance and control of energy systems.

The many control functions include options for setting switching times, operating programs, holiday programs and set values (level/slope), checking operating states and temperatures, and adjusting codes. In addition, energy consumption can be shown and used as the basis for billing. Fault messages are sent to the service engineer by SMS or email.

#### **Vitocom 300 LAN with maximum data security**

The LAN version of the Vitocom 300 enables data transfer via DSL/ Ethernet networks at speeds of up to 100 MB/s. Data encryption guarantees a maximum level of security.

#### **Vitogate 300 interface for building automation**

Vitogate 300 is the ideal solution for connecting boilers or heat pumps to the building management system via a standardised BACnet or Modbus protocol. Via the gateway, the energy system can be visualised in and operated from the control centre. This allows users to gather information about the current status of their system and make individual settings.



**Vitogate 300**

## Heating water buffer cylinders

---



### VITOCCELL 160-E

**Heating water buffer cylinder** in conjunction with solar thermal systems, heat pumps and solid fuel boilers  
With stratification system

#### Type SESB

Cylinder capacity: 750 / 950 litres

---



### VITOCCELL 140-E

**Heating water buffer cylinder** in conjunction with solar thermal systems, heat pumps and solid fuel boilers

#### Type SEIA (with Solar-Divicon)

Cylinder capacity: 400 litres

Energy efficiency class: B

#### Type SEIC

Cylinder capacity: 600 / 750 / 950 litres

---



### VITOCCELL 120-E

#### Cylinder for heating water storage and DHW heating with the Vitotrans 353

in conjunction with heat pumps

#### Type SVW

Cylinder capacity: 600 / 950 litres

---



### VITOCCELL 100-E

#### Cylinder for storing heating water 46 to 2000 l

#### Type SVPA

Cylinder capacity: 46 / 400 litres

Energy efficiency class: B

#### Type SVWA

Cylinder capacity: 200 litres

Energy efficiency class: B

#### Type SVPB

Cylinder capacity: 600 / 750 / 950 / 1500 / 2000 litres

---



Scan the QR code for further information about heating water buffer cylinders.

## Freshwater modules

---



### VITOTRANS 353

**Pre-assembled modules for convenient DHW heating using the instantaneous water heating principle**

for mounting on the cylinder

**Type PBSA** (up to 25 l/min)

**Type PBMA** (up to 48 l/min)



### VITOTRANS 353

**Pre-assembled modules for convenient DHW heating using the instantaneous water heating principle**

for wall mounting

**Type PBLA** (up to 68 l/min)

## Cylinder loading system

---



### VITOTRANS 222

**Heat exchanger set for cylinder loading system**

Transferable heating output: up to 80 / 120 / 240 kW



Scan the QR code for further information about freshwater modules.



PEWO is our competent partner for heat interface units. For further information, please scan the QR code.

Essentially, heat interface units distribute heating energy in residential buildings. The heat provided by central heat generators or district heating networks is available in the individual apartments for room heating and domestic hot water.

In multi-storey apartment buildings, consistently high DHW quality is of particular importance. This is ensured by heat interface units with a connected heat load of 28 to 56 kilowatts. The patented TFS controller ensures hot water at a constant temperature at all times.



The specific water temperature required in each residential unit can be set via the TFS controller.

### Therm T and Therm V

The compact heat interface units in the Therm range are designed for connection to the decentralised heating water and drinking water supply. The Therm units are divided into two main groups: Therm T and Therm V. With Therm V, heating and DHW can be provided at the same time. With Therm T, DHW heating has priority over heating.

### DHW heating

Therm T and Therm V are designed in such a way that the standing water volume in the system is very low. The stainless steel plate heat exchanger has a high thermal length which allows optimum use of the available heating water flow rate. This ensures the high energy efficiency of the entire system. The heat exchanger is prevented from cooling down during usage-related downtimes by the bypass function of the TFS controller. The benefit: even after a longer period of non-use, perfectly hygienic water at the required temperature is available from the tap in the shortest possible time.

### TFS control

The patented Thermo Fluid System (TFS) regulates the DHW heating according to demand. In contrast to proportional controllers, this thermostatic controller has its measuring probe positioned directly in the heat exchanger, so that an extremely low latency time is achieved after starting as well as restarting. The hydraulics are designed in such a way that there are almost no mechanical parts in water-carrying areas. This prevents dead zones where impurities or limescale could form. The result is a hygienic DHW supply and a particularly durable and low-maintenance product.



Particularly slimline version for installation between drywall studs

### Room heating

Optional components for room heating, such as a second heating circuit or an underfloor heating circuit manifold, can be integrated into both Therm series. There is a direct connection to the primary circuit, i.e. the heating water coming from the heat supply also flows through the radiators or heating surfaces. The heat interface units are available in a surface mounted or flush mounted casing.

### THERM V

This heat interface unit is designed to replace a gas heating system for an individual storey. The basic equipment level includes the copper brazed plate heat exchanger, which is optionally available as a stainless steel brazed version, as well as a heating circuit without mixer, and dirt traps. The heat interface unit is particularly suitable for providing heating and domestic hot water in apartments. DHW heating takes priority in this case.



#### Therm T Slimline

- DHW output: 35 kW
- Heating: up to 10 kW
- Copper brazed plate heat exchanger up to 16 l/min
- Differential pressure regulator
- Heating circuit without mixer
- Cold water outlet
- 7 ball valves
- Thermal insulation



#### Therm T Combi

- DHW output: 28 to 51 kW
- Heating: up to 10 kW
- Copper brazed plate heat exchanger up to 16 l/min
- Electric instantaneous water heater: 11 kW
- Differential pressure regulator
- Thermostatic heating circuit with mixer
- Contact thermostat with thermal actuator
- Cold water outlet
- 7 ball valves
- Thermal insulation



#### Therm T 4L

- DHW output: 35 to 56 kW
- Heating: up to 10 kW
- Copper brazed plate heat exchanger up to 16 l/min
- Differential pressure regulator
- High temperature/low temperature heating circuit
- Differential pressure regulator for low temperature heating circuit
- Flow rate controller for DHW outlet
- Cold water outlet
- 9 ball valves
- Thermal insulation



#### Therm V

- DHW output: 35 kW
- Heating: up to 12 kW
- Copper brazed plate heat exchanger up to 16 l/min
- Differential pressure regulator
- High temperature/low temperature heating circuit
- Differential pressure regulator for low temperature heating circuit
- Flow rate controller for DHW outlet
- Cold water outlet
- 9 ball valves
- Thermal insulation



Solar  
KEYMARK

**Vitosol 200-T** (type SPX)  
Vacuum tube collector for large scale  
solar thermal systems



Vitosol 200-T vacuum tube collectors (type SPX) are suitable for freestanding installation on supports or mounting on flat roofs.

Viessmann offers the Vitosol 200-T vacuum tube collectors (type SPX) on a project-specific basis. Two modules are available. In the 5.05 square metre standard version, the headers and tubes are assembled at the construction site. This is recommended for collector surface areas of 200 to 600 square metres.

The 10.3 square metre collector consists of a casing, vacuum tubes and a mounting frame, and is supplied prefabricated. It can be installed rapidly using a crane. This is the ideal size for applications in local heating networks (such as bioenergy villages) and for generating industrial process heat.

#### **Heat pipe principle for high operational reliability**

Thanks to the heat pipe principle, the Vitosol 200-T (type SPX) offers high operational reliability. Its vacuum tube technology makes network temperatures of up to 120 °C possible. Dry connection means that tubes can be inserted or changed even while the system is full. Further benefits include highly efficient operation, low pressure drop and simple hydraulic construction.

#### **Frost protection with glycol or water**

For frost protection, the collectors can be filled with a water/propylene glycol mixture (passive) or water only (active). They can therefore meet individual specifications, depending on customer requirements and environmental conditions (e.g. water protection area).

#### **Flexible installation including accessories**

The Vitosol 200-T (type SPX) is suitable for freestanding installation on supports, or mounting on-roof or on supports on flat or pitched roofs. All the required components, such as the transfer station, controller, pipework and services, are also available.

## VITOSOL 200-T

TYPE SPX

5.05 M<sup>2</sup> / 10.3 M<sup>2</sup>

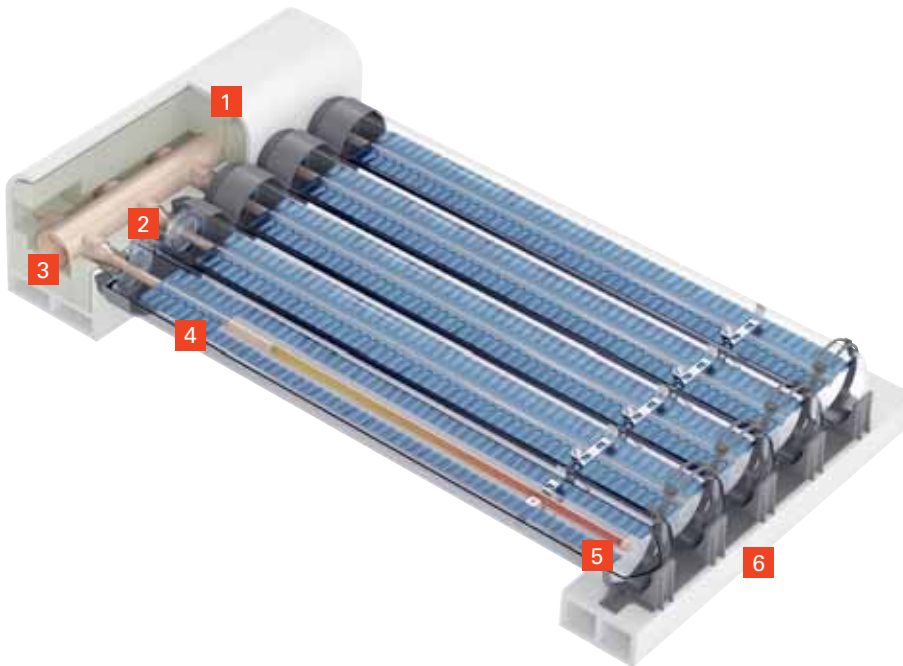

### VITOSOL 200-T

- 1 Collector casing with highly effective thermal insulation
- 2 Dry connection, no direct contact between process medium and heat transfer medium
- 3 Header for connection on either side
- 4 Absorber panel with selective coating inside the vacuum tubes
- 5 Heat pipe
- 6 Base rail

**Version 1:**  
Type SPX-H (horizontal)  
Mounting angle 3 to 20 degrees



**Version 2:**  
Type SPX-S (standard)  
Mounting angle 20 to 60 degrees



### BENEFITS AT A GLANCE

- + Individual design and complete project management by Viessmann
- + Modules pre-assembled at the factory
- + Durable, robust construction and low maintenance costs
- + Dry connection, meaning vacuum tubes can be inserted or changed while the system is full
- + Network temperatures up to 120 °C



Each container can be individually equipped and painted in any RAL colour.



Heating systems in standard containers are the ideal solution for commercial enterprises and smaller residential estates for which a boiler house is not envisaged or where building costs have to be kept low.

Viessmann supplies powerful turnkey systems with short installation times. Particularly economical solutions are systems for simultaneous heat and power generation or for operation with renewable energy sources.

### **Renewable energy systems**

The Vitoflex 300-RF automatic solid fuel boiler with patented rotation combustion is recommended for the use of biomass such as pellets, woodchips or wood shavings. A feed screw conveyor continuously guides the fuel onto a moving grate, on which efficient combustion takes place.

A second container to store the fuel makes the best possible use of the space available. It can be set on top of the floorstanding heating container to save space. The fuel falls through a drop chute into the supply screw conveyor of the boiler. This solution does not require any complicated conveyor devices.

### **Power and heat from a container**

The combination of a Vitobloc 200 combined heat and power unit (CHP unit) and Vitoplex gas boiler is also a particularly economical option.

The CHP unit generates heat and power simultaneously, which can be consumed directly in the property. Cogeneration saves up to 30 percent primary energy and reduces the amount of electricity drawn from the public grid.

If the amount of heat is not sufficient, the gas boiler covers peak loads.



Ready-made, space saving solution of a container heating system with Vitoflex 300-RF and a piggyback fuel container



Container version with Vitobloc 200 CHP unit and Vitoplex low temperature gas boiler. Both heating systems can operate with natural gas or biogas.

### **BENEFITS AT A GLANCE**

- + Compact energy systems for residential complexes and commercial enterprises
- + Ideal for temporary heat provision, for example whilst a heating system is being modernised
- + Lower cost solution compared to energy systems installed inside the building
- + Acoustic separation due to outdoor installation
- + Ready to use on delivery with rapid connection to the heating network
- + Simple fuel delivery for versions with biomass boiler
- + Flexible equipment and siting

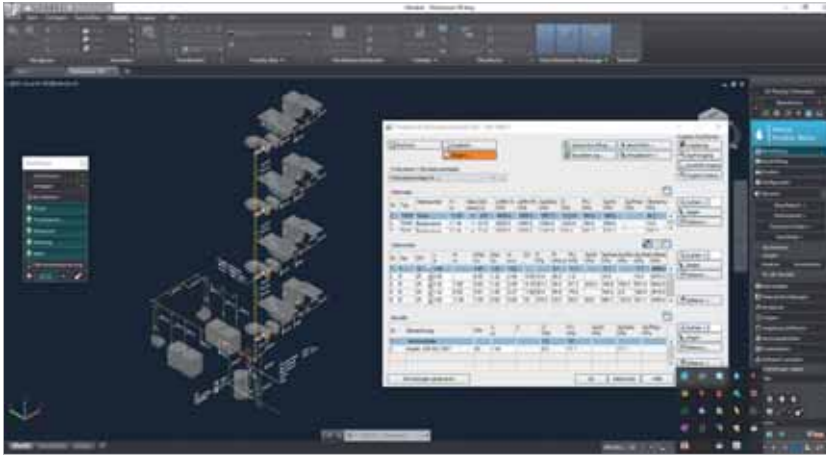

3D representation and design of DHW pipework including DHW circulation

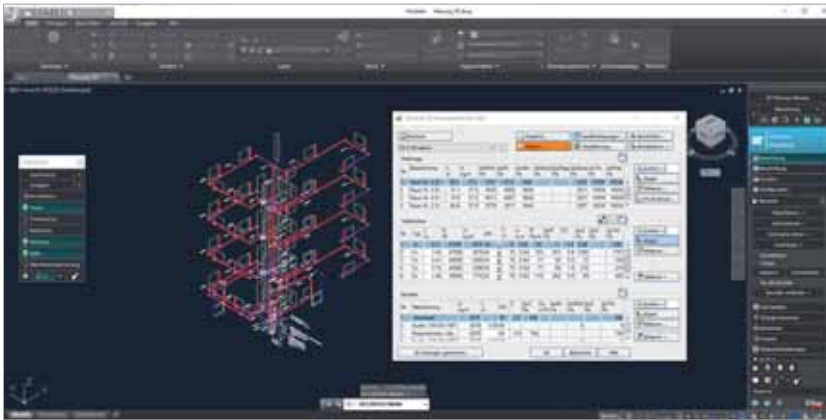

Improved reporting for the design of heating pipework

The proven Vitodesk 200 and Vitodesk 300 planning programs have now been expanded to include additional functions. The fee-based software packages vary in their design for use in construction projects of different sizes. A key feature of Vitodesk 300 is CAD planning in 3D.

#### **Vitodesk 200 is suitable for all system sizes**

Vitodesk 200 is the right tool for basic evaluation of building services. The software is suitable for all system sizes – from detached houses to residential complexes. Vitodesk 200 includes all the necessary tools for calculating heating and sanitary installations, such as the U-value calculation as well as determination of the heat load according to DIN EN 12831 and the cooling load according to VDI 2078.

#### **Individual design with Vitodesk 300**

Large building projects can be designed individually and easily with Vitodesk 300. The software features programs for graphic design engineering using CAD. These include tools for 3D boiler room engineering and 2D and 3D pipework calculations.

The individual program modules for heating, DHW, waste water and gas are consistent in all display modes: schematically, in a floor plan or three-dimensionally with simplified capture of pipework. Additional buttons and functions offer greater flexibility and an overview of the design and engineering process for complex heating systems.

Further information on Vitodesk is available in the PartnerPortal and from the relevant sales office.

These functions are **NEW**:

- Individual designation of the components
- Extended functions for plotting supply lines in area heating systems
- Selection and deselection of all labelling parameters with one click
- Simplified classification and definition of components
- VDI 2072 for calculating the simultaneity of heat interface units
- Calculation of the draw-off rate of heat interface units based on DIN 4708 or VDI 6003
- VDI 6003 for determining discharge times
- Extension of IFC export for optional exclusion of systems
- IFC import for AutoCAD files
- IFC categorisation for components
- Determination of the water capacity of heating systems
- Inclusion of modelled dimensions in the calculation
- Reports from pipework and sewer system calculations
- Partial network start with pump in heating and cooling design
- Calculation of 6-way valves
- Selection of additional hydraulic circuits
- Selection of the flush-relevant consumer for flow dividers
- Display of linked partial network starts and ends
- Printout of total water quantities for potable water consumers and waste water objects
- Support for priority control for DHW cylinders
- Inclusion of flow dividers in the DHW pipework calculation
- Connection of drainage system in 3D
- Gas pressure drop calculation according to Renouard

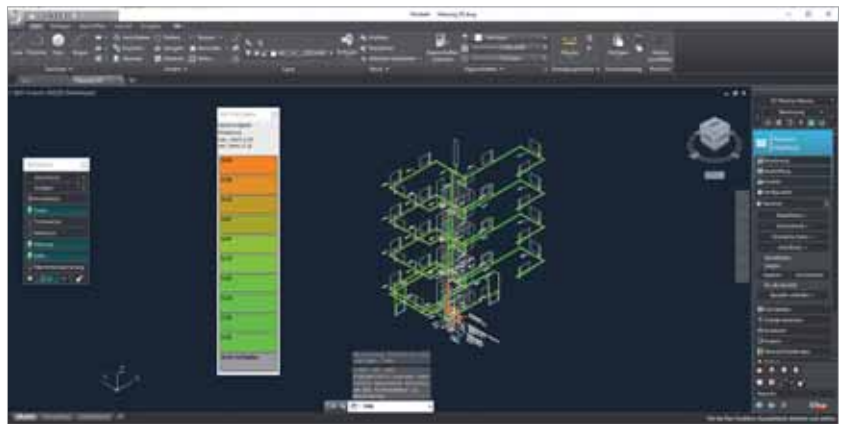
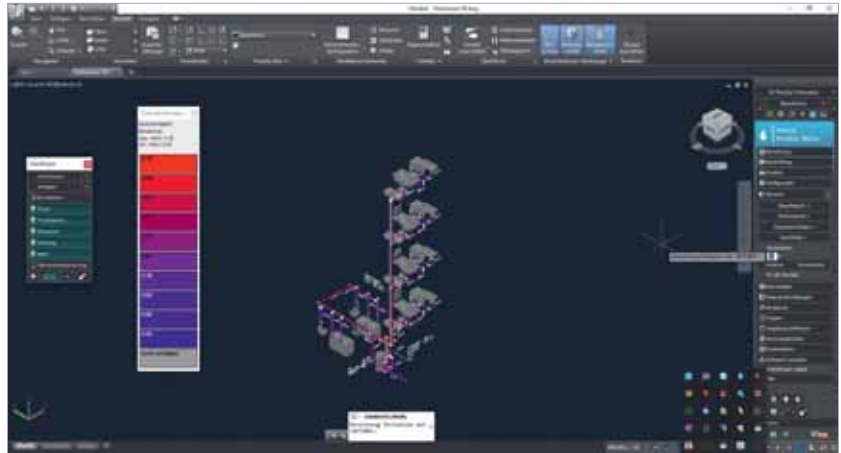

The improved analysis function provides information about heat loss, for example, or the flow rate of DHW and heating systems.



The Service Plus concept from Viessmann: modular service packages for all requirements – for long-term planning and efficient, reliable operation

You can rely on Viessmann. From commissioning, instruction and training to a long-term guarantee on complete energy systems, every customer receives an individual, all-inclusive support package.

Viessmann offers its customers effective value added services and digital service solutions that let them operate their energy systems even more efficiently – with maximum convenience and the highest possible safety levels. As a result, system users not only benefit from

convenient operation and services via app, but can also count on Viessmann's proven customer service. In addition to a transparent overview of all systems, including configuration, warranty periods and service history, the diverse portfolio also includes self-service options and simplified ways to contact the Technical Service. From system-specific commissioning to full service contracts, Service Plus offers perfectly tailored solutions for maximum customer satisfaction.

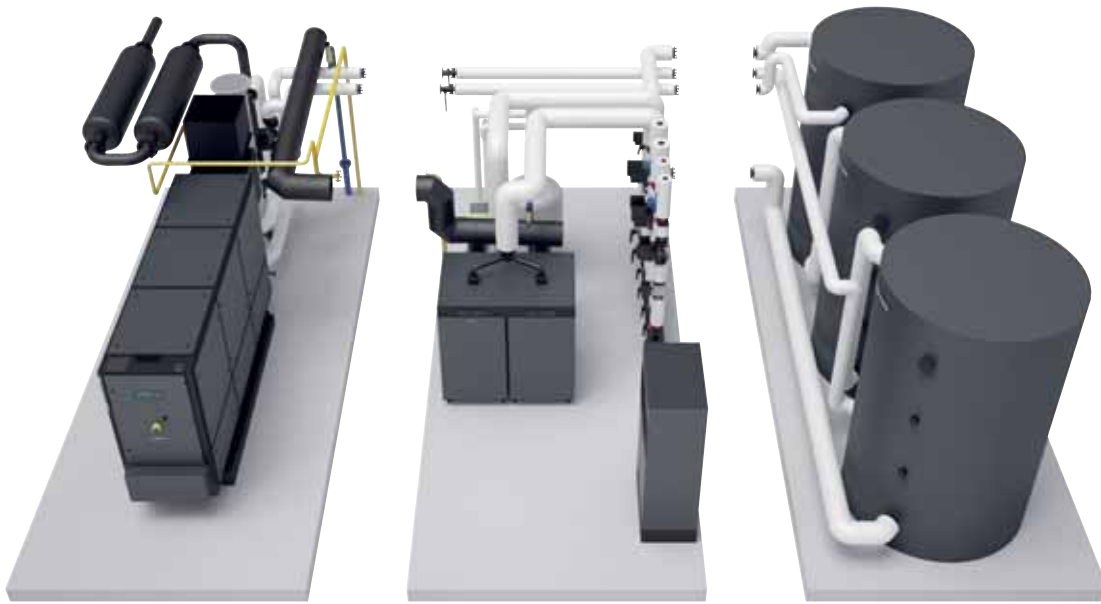

Schematic representation of an energy system. From left: Vitobloc CHP unit for generating heat and power, Vitocrossal 200 (type CIB) for the peak heat load and three heating water buffer cylinders



Regular employee training through the Viessmann Academy





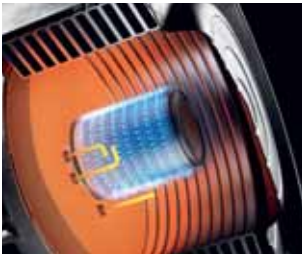



#### BENEFITS AT A GLANCE

- + Support with installation and system-specific commissioning as well as needs-based training on the energy system
- + Digital connection for convenient operation and services via app
- + Regular inspection and maintenance for higher efficiency and extended service life as well as energy cost savings and careful handling of resources
- + Early detection of faults and rapid troubleshooting by Viessmann customer service
- + Guarantee packages and service contracts for full planning and cost certainty
- + Regular employee training through the Viessmann Academy



**Technology that looks to the future:**  
Specially developed by Viessmann, the MatriX-Plus burner plays a key role in using hydrogen as an energy source

 | H2 READY

<b>Value added services</b>	Wärme Leads	ViShare Service Plus	Strom Logistik Plus	FörderProfi ...
<b>Digital services</b>	 ViCare	 ViGuide	 ViScada	...
<b>Connectivity &amp; platforms</b>	 Connectivity Inside	 Energy Management Inside	 Vitoconnect	 Vitocontrol
<b>Products &amp; systems</b>				

Seamless integration of products and systems with digital services and value added services for system users and trade partners

\* Energy Market Solutions GmbH (EMS), a stakeholder in the Viessmann Group, is the operator and contractual partner in the ViShare Energy Community.

We are Viessmann, a family business. Founded in 1917 as a heating technology manufacturer, today we are the world's leading provider of sustainable climate (heating, cooling and air quality) and renewable energy solutions.

Our integrated range of solutions seamlessly connects products and systems via digital platforms and services, creating an individualised feel-good climate for our users. All our activities are driven by the corporate mission statement, "We create living spaces for generations to come". This is the responsibility that we, the 12,750 members of the Viessmann family, take on every day together with our (trade) partners.



**We create living spaces for generations to come.**



Number 1 Trade Partner – for the 16th consecutive time

**Practical partnership**

As part of its comprehensive range, Viessmann also offers a wide selection of value added services. These include an extensive training and further development programme for trade partners at the well equipped training facilities of the Viessmann Academy.

With its new digital services, Viessmann offers innovative solutions such as the operation and monitoring of heating systems by smartphone. Users benefit from greater reassurance and convenience, whilst contractors can keep a constant eye on the systems for which they are responsible.



As a family company in its fourth generation, we take a long term view: we create living spaces for generations to come. This mission statement guides the actions of all employees in the large Viessmann family.

#### VISSMANN GROUP IN FIGURES

1917	— Viessmann was founded
12 750	— employees
2.80	— Group turnover in billions of euros
54	— export share in percent
22	— manufacturing sites in 12 countries
74	— sales companies in 43 countries
120	— sales offices worldwide



Viessmann Climate Solutions SE  
35107 Allendorf (Eder)  
Germany  
Telephone: +49 6452 70-0  
[www.viessmann.de](http://www.viessmann.de)

06/2022 EN

Copyright Viessmann.  
Duplication and alternative use  
only with prior consent.  
Subject to modifications.