



TECHNOLOGY BROCHURE

Mechanical ventilation systems

**VITOAIR**  
**VITOVENT**



**Mechanical  
ventilation systems**

Efficient and  
economically  
interesting solutions  
for new build and  
modernisation projects



Controlled mechanical ventilation ensures a comfortable room climate and protects the fabric of the building.

Whether in a house or an apartment – only regular air changes ensure consistently high air quality for the residents. Otherwise, the consumed air does not contain much oxygen, but does carry substances such as carbon dioxide and water vapour. Oxygen is vital for the human body.

In addition, high air quality aids our physical and mental abilities, and ensures we experience a noticeable feeling of wellbeing. Ultimately, the purity of the air is also an indicator of quality of life, the importance of which cannot be overstated.



4



6



8



12



36



52

#### 4 SAVE ENERGY AND PROTECT THE CLIMATE

Controlled mechanical ventilation ensures a healthy room climate and protects the fabric of the building.

#### 6 CENTRAL VENTILATION IN NEW BUILD

The installation of mechanical ventilation systems in new detached houses is already standard, especially in low energy and passive houses.

#### 8 DECENTRALISED VENTILATION FOR EXISTING BUILDINGS AND MODERNISATION PROJECTS

Decentralised ventilation units can be installed in specific individual rooms.

#### 12 CENTRAL MECHANICAL VENTILATION UNITS

#### 36 DECENTRALISED MECHANICAL VENTILATION UNITS

#### 52 PLANNING, SERVICING AND MAINTENANCE

Durable in use – easy to maintain.





Controlled mechanical ventilation ensures a comfortable room climate and protects the fabric of the building.

In recent years, more stringent building regulations have led to sustainable energy savings, particularly in the construction of new houses and apartments. For example, in existing housing, the annual heat demand for a detached house is approx. 200 kWh/m<sup>2</sup>. For a comparable new house, built in line with the latest Energy Saving Ordinance (EnEV – Germany), the annual heat demand is

only around a quarter of that figure.

Use of new building and insulating materials results in an airtight construction that no longer provides the necessary minimum air change rate in the interior.



**Mechanical ventilation for consistent room air quality**

An adequate air change rate is essential for health and wellbeing, as well as for protecting the fabric of the building.

A mechanical ventilation system is ideal for this. It prevents mould growth and ensures controlled replacement of stale indoor air with fresh, filtered outdoor air.

Controlled mechanical ventilation continuously extracts stale air, for example from bathrooms, kitchens and toilets, and replaces it with fresh air in living areas, playrooms and bedrooms. This ensures consistently high air quality.

In an average detached house, up to 15 litres of humidity are transferred to the indoor air every day. An amount accounted for in less than a minute when showering. In older buildings, this humidity condenses at cold points on the walls, resulting in a risk of mould growth.

In the past, this problem was contained by natural ventilation through draughty door and window frames. However, such draughts no longer arise in energy efficient new buildings and existing buildings modernised in

line with EnEV specifications.

**Legal requirements stipulate a minimum air change rate**

EnEV specifications compel building owners to guarantee an adequate minimum air change rate in their buildings. Residents are usually out of the house during the day, which means that the necessary ventilation does not take place.

A mechanical ventilation system operates continuously, thereby

preventing adverse effects for residents as well as damage to the building.

**Allergy sufferers can breathe more easily**

Allergy sufferers really appreciate mechanical ventilation systems – fitted with effective pollen filters, they reduce the pollution level so that those affected suffer less from allergic reactions, while still being able to breathe fresh air.

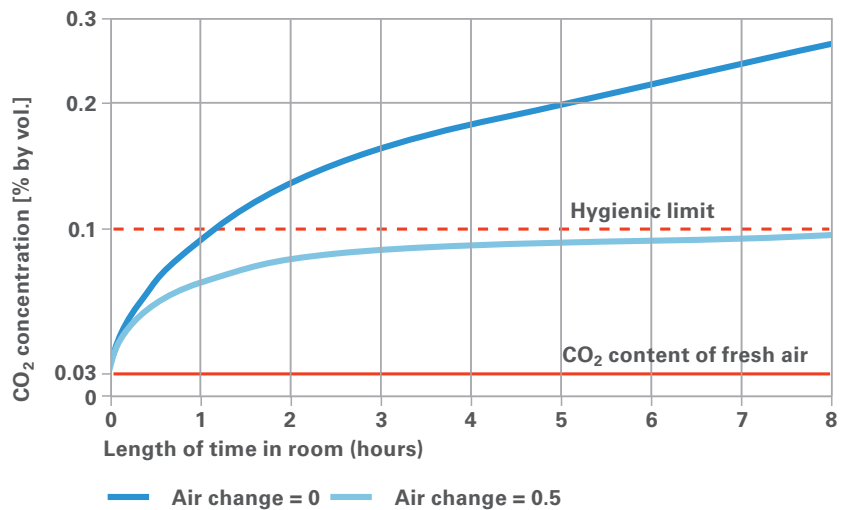

CO<sub>2</sub> concentration in residential buildings

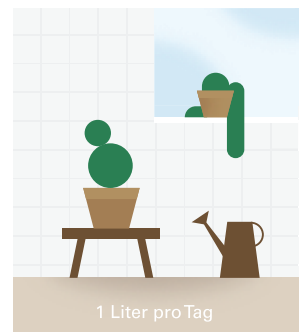
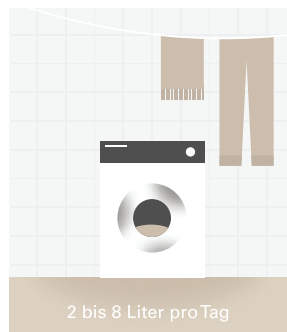
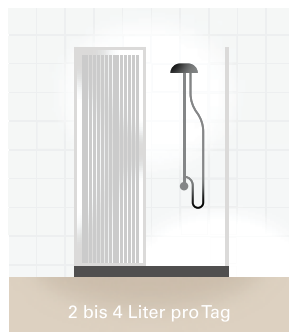
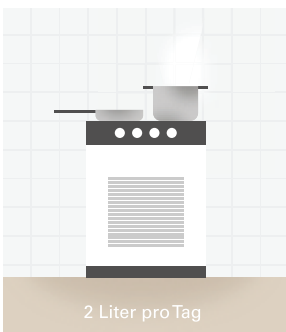

Release of humidity: up to 15 litres a day in a 4-person household



# Central ventilation in new build

Mechanical ventilation systems are generally fitted in most new construction projects. On the one hand, this requires a high level of energy efficient insulation in order to regulate the room air humidity as effectively as possible, and on the other, it is seen as a convenience feature for high grade internal fittings of the residential unit or apartment block.

## **Mechanical ventilation in detached houses**

The installation of mechanical ventilation systems in new detached houses is already standard, especially in low energy and passive houses.

Consequently, no heat is lost through accidental ventilation in the colder months, and the continuous air exchange ensures a consistently high level of indoor air quality.

## **Heat recovery from extract air**

Today's mechanical ventilation systems are particularly energy efficient: a powerful heat exchanger recovers up to 98 percent of the latent heat in the extract air and uses it to heat the incoming fresh air. This reduces household expenditure perceptibly thanks to a significantly lower energy demand. CO<sub>2</sub> emissions are reduced at the same time.

Every new build equipped with mechanical ventilation has a central unit that supplies all rooms with fresh air via a duct system. In most cases, the duct system is concealed in the floor or integrated into the walls. Air diffusers are all that remain visible. The ventilation centre controls air exchange automatically.

## **Quiet operation**

The noise emissions of a central mechanical ventilation system are extremely low. Get the sizing and configuration right, and there is no air noise. The system protects against the incursion of external noise. In addition, silencers can be installed in individual air ducts for especially sensitive rooms.



Vitocal 222-A heat pump with Vitoair FS mechanical ventilation system and Vitocharge power storage unit: a central mechanical ventilation system is already standard in new buildings.





# Decentralised ventilation for modernisation of existing buildings

The modernisation of energy systems in existing buildings is constantly being driven by rising energy costs in the housing industry. Old buildings are being extensively modernised and offer their residents new levels of comfort – through the installation of energy efficient windows and doors, façade insulation or a heating system with convenient DHW heating.

## **Risks associated with modernisation**

Modernisation also carries a risk of older apartments becoming so airtight that no adequate fresh air change can take place. The consequence is high humidity levels in the interior, which can lead to mould growth, especially in buildings with insulated external walls. Areas that are particularly at risk are the corners of rooms next to external walls, as this is where humidity condenses.

A central ventilation system can be ruled out in most existing buildings, since there is frequently insufficient space to install ventilation ducts in the interior. A decentralised system with heat recovery is the most suitable solution in this case.

## **Ventilating rooms individually**

Decentralised ventilation units can be installed in specific individual rooms. All that is required for a straightforward installation is a wall outlet or a hole through the external wall of the respective room and a power supply. No ventilation ducts need to be installed for this system.

Residential units can be equipped with several units that operate independently of each other. These are ideal for providing a comfortable room climate with the required minimum air change rate. These units feature a heat recovery level of up to 91 percent.



Unobtrusive appearance through installation of the Vitovent 100-D in the window reveal.



## Reliable, durable technology – why it's essential

Viessmann mechanical ventilation systems are characterised by their innovative technology. They are durable, reliable and operate particularly quietly. With different equipment levels, they can be employed flexibly in the widest range of applications imaginable, no matter whether in a new building or the modernisation of an existing building. Overview of the main functions:

### CO<sub>2</sub> and humidity control

Air is considered to be fresh when the CO<sub>2</sub> concentration is below 0.1 percent by volume and it is as free as possible from odours. Vitovent systems change the air continuously to create a pleasant and healthy room climate. They remove odours and pollutants, replacing more or less air depending on the prevailing humidity levels, thereby removing humidity (subject to outdoor air humidity and weather conditions).

### Passive cooling in the summer

During the warmer months of the year and depending on the outside and room temperatures, fresh night air can be used for air tempering in the living space. Heat recovery is temporarily deactivated for this purpose. All versions of the Vitovent mechanical ventilation unit come with this function.

### Heat exchanger for heat recovery

Up to 99 percent of the heat in the extract air is used for supply air heating thanks to the integral heat exchanger. This reduces heating energy and protects the environment.

### Automatic control of the air supply

Contaminated filters lead to greater air resistance. Central ventilation systems therefore make automatic readjustments to ensure that the necessary air volume

for comfort and hygiene is still supplied and extracted at all times.

### Automatic filter monitoring

The integral filters comply with strict requirements. They must filter dust and pollen reliably from the fresh air. Pollen filters with filter category ISO ePM1 70 percent (previously F7) are available for all central ventilation units.

Regular filter changes are required to ensure that everything runs smoothly. The active monitoring system indicates the need for replacement in good time.

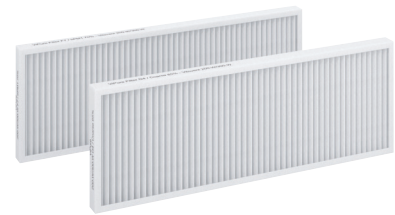

Dust and pollen are filtered reliably.

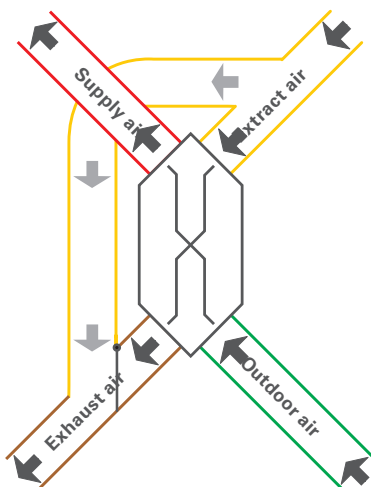

Function of the integral bypass damper: fresh outdoor air (green) is routed past the cross-counter-current heat exchanger.



# Vitoair – Vitovent



For new build and modernisation projects, Viessmann offers ideal solutions which satisfy almost all requirements.

### **Vitoair – integral component of Viessmann One Base**

The new Vitoair FS ultra-compact mechanical ventilation unit sets new standards for convenience and system integration. It is an integral component of Viessmann One Base (see page 20/21) and can be directly combined with Viessmann Vitodens gas condensing boilers or the new generation of Vitocal heat pumps.

The addition of a photovoltaic system and a Vitocharge VX3 power storage unit for self-generated power is also possible at any time. The Vitoair FS and Vitocal can then

be operated almost completely independently of the public grid. With the ViCare app, users can conveniently control their entire energy system at any time from anywhere.

### **Control Vitovent centrally with Vitotronic**

The mechanical ventilation systems in the Vitovent family have proven their worth over many years. When used in combination with a Vitocal heat pump, both units can be controlled via the Vitotronic control unit of the heat pump. However, both units are compatible with Viessmann One Base when connected via the optional Vitoconnect online interface, and they can then also be conveniently controlled from a smartphone with the ViCare app.



Central and decentralised mechanical ventilation systems offer the best solution for every application in new or existing buildings. The units are designed for ventilation of spaces ranging from individual rooms to large residential units measuring up to approx. 440 m<sup>2</sup>.

## Mechanical ventilation systems with heat recovery



### **VITOAIR FS**

Ceiling mounted mechanical ventilation system with heat recovery

Max. air flow rate: 300 m<sup>3</sup>/h

Heat recovery level: up to 80 %

Humidity control: up to 74 %

[Page 14](#)



### **VITOVENT 300-W**

Wall mounted mechanical ventilation system with heat recovery

Max. air flow rate: 225, 325 or 400 m<sup>3</sup>/h

Heat recovery level: up to 99 %

[Page 16](#)



### **VITOVENT 300-C**

Ceiling or wall mounted mechanical ventilation system with heat recovery

Max. air flow rate: 150 m<sup>3</sup>/h

Heat recovery level: up to 89 %

[Page 18](#)



### **VITOVENT 200-C**

Ceiling mounted mechanical ventilation system with heat recovery

Max. air flow rate: 200 m<sup>3</sup>/h

Heat recovery level: up to 95 %

[Page 19](#)

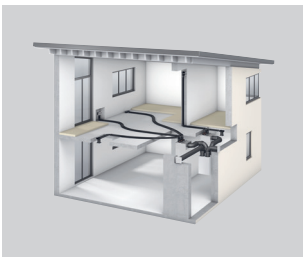

### **Air distribution systems for Vitovent mechanical ventilation units**

For distributing supply air and extract air in the building

[Page 26](#)



## Vitoair FS



Vitoair FS product animation – the most compact ventilation unit in its class

With its low installed height of 245 millimetres and a maximum air flow rate of 300 m<sup>3</sup>/h, the Vitoair FS mechanical ventilation system is not only especially slimline, it is also very compact. Furthermore, it operates very quietly even when running at a high level.

### System integration with Viessmann One Base

Vitoair FS is compatible with Viessmann One Base and can be seamlessly combined with Viessmann Vitodens gas condensing boilers or Vitocal heat pumps. The addition of a Vitovolt photovoltaic system and a Vitocharge VX3 power storage unit for self-generated power is also possible at any time. Vitoair FS and Vitocal can then be operated almost completely independently of the public grid.

### Optimum indoor air quality thanks to heat exchanger

The special polymer membranes of the recuperative enthalpy heat exchanger in the Vitoair FS not only recover heat, but also moisture. This helps keep indoor air pleasant and contributes to a sense of wellbeing.

The water vapour molecules contained in the extract air diffuse through the membrane and are absorbed by the outdoor air on the supply air side. This reduces the amount of indoor air that is too dry or too humid. The fact that the polymer membrane also prevents the transmission of viruses, mould and bacteria makes Vitoair FS a hygienically perfect solution.

### Straightforward installation and commissioning

There are a number of installation options: below the ceiling, on the wall or horizontally in the attic. The connector arrangement can be adapted to the respective conditions. No condensate drain is required.

With the ViCare app, users can conveniently control their entire energy system at all times. There is also the option to allow the trade partner to monitor the system remotely and rectify faults either immediately online or by means of a quick service call.

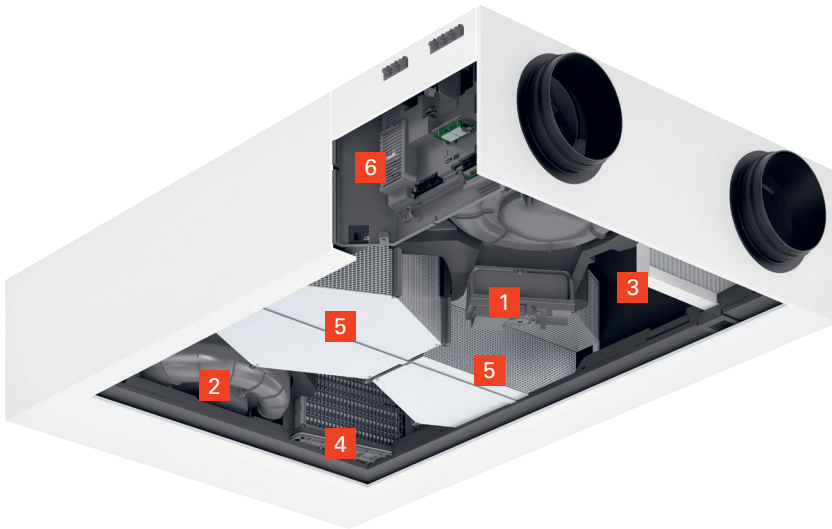

**VITOAIR FS**

- 1** Bypass damper
- 2** EC constant volume fan with flow rate measurement
- 3** Filter
- 4** Preheating coil (optional)
- 5** Enthalpy heat exchanger
- 6** Control PCB

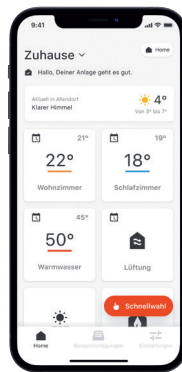

**ViCare app**  
Control of the entire energy system

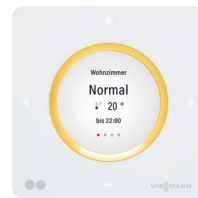

**Vitolol 300-E**  
Convenient wireless remote control as an accessory



**4-stage pushbutton**  
With filter change indicator

**BENEFITS AT A GLANCE**

- + Low energy costs thanks to high heat recovery
- + Minimal electricity costs through low power consumption
- + Modest space requirement, e.g. in a suspended ceiling
- + Thermal comfort and healthy room climate
- + Balanced humidity management prevents mould growth and damage to the building
- + Increased protection against burglary and noise as windows can be kept closed
- + Filtration of the outdoor air – important for allergy sufferers
- + System control via ViCare app (optional remote control)
- + Compatible with Viessmann One Base
- + Connector arrangement for the air distribution system optionally as right or left-handed version
- + No condensate drain required
- + Easy commissioning and online monitoring by the trade partner

For specification, see page 54

## Vitovent 300-W



### Vitovent 300-W

Mechanical ventilation system with three output stages

The Vitovent 300-W mechanical ventilation system changes the air continuously for a pleasant and healthy room climate, removing odours and pollutants. The version with a maximum flow rate of 225 m<sup>3</sup>/h is recommended for apartments and apartment buildings.

For detached and two-family houses with living areas of 320 to 440 square metres, a system with an output of up to 400 m<sup>3</sup>/h should be used.

Constant flow rate and balance control are independent of the static pressure and allow quick and easy adjustment of flow rates via the remote control unit.

### Control and monitoring via app

When combined with a Vitocal heat pump, it can be conveniently controlled using the ViCare app. Trade partners have the option of using ViGuide to check online using a web browser to see whether the Vitovent 300-W is functioning properly.

### Extract air heats incoming fresh air

The central system ventilates with almost no energy loss. It also works extremely energy efficiently. During the colder months, the heat exchanger utilises up to 92 percent of the latent energy in the extract air to preheat the incoming fresh air. The electric preheating coil ensures frost-free operation even at low outside temperatures.

### Passive cooling the natural way

During the warmer months, the heat exchanger of the Vitovent 300-W can be bypassed completely via the integral automatic bypass damper. This temperature-controlled circuit allows cool outdoor air to enter the interior at night, thereby ensuring a pleasantly fresh environment.

### Allergy sufferers breathe easier

A filtration system featuring an effective optional pollen filter cleans the supply air of allergens and pollutants. This significantly reduces the spread of mites and mildew, and creates an irritant-free room climate.





**VITOVENT 300-W**

- 1 Bypass damper
- 2 EC constant volume fans with flow rate measurement
- 3 Extract air filter
- 4 Preheating coil
- 5 Countercurrent heat exchanger
- 6 Outdoor air filter

**BENEFITS AT A GLANCE**

- + High control intelligence and low installation effort
- + Virtually silent operation
- + A very high heat recovery level minimises ventilation heat losses and lowers heating bills
- + Convenient control via the heat pump and ventilation programming unit

For specification, see page 55



Ventilation programming unit, type LB1

## Vitovent 300-C

Vitovent 300-C is primarily suited to controlled ventilation of apartments. With its output of up to 150 m<sup>3</sup>/h, the system is suitable for apartments with a living space of up to 90 square metres.

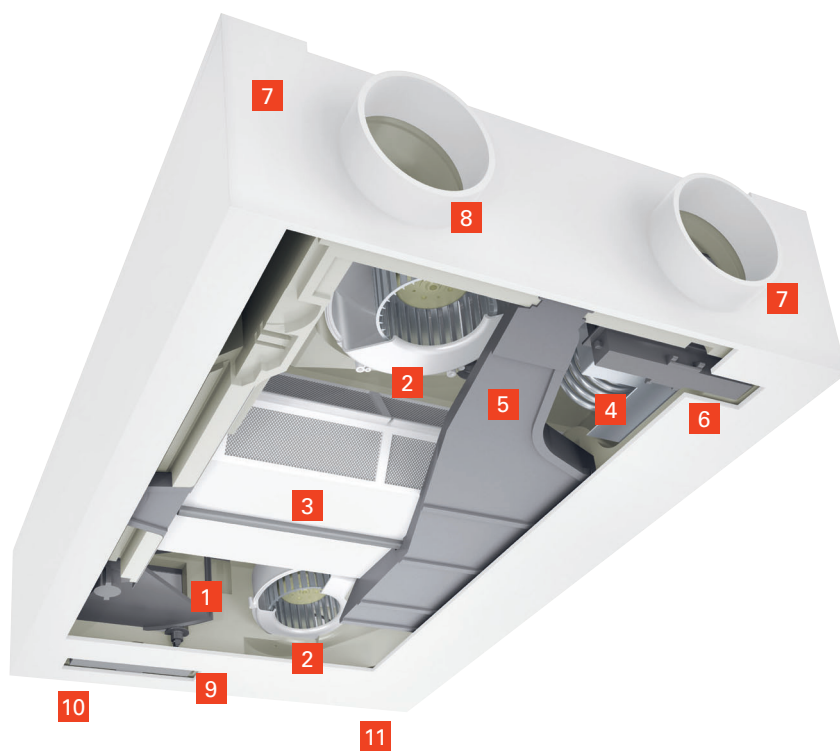

### VITOVENT 300-C

- 1 Bypass
- 2 Radial DC fans
- 3 Cross-countercurrent heat exchanger
- 4 Electric preheating coil
- 5 Condensate drain
- 6 Outdoor air filter
- 7 Outdoor air
- 8 Exhaust air
- 9 Extract air filter
- 10 Extract air
- 11 Supply air

### BENEFITS AT A GLANCE

- + Compact design – just 19.8 cm high
- + Ideal for ceiling or wall mounted installation
- + Designed for smaller houses and apartments
- + Integral preheating coil for frost protection and efficient heat recovery all year round

For specification, see page 56

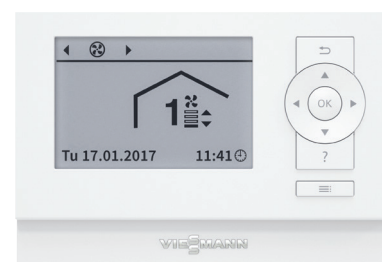

Ventilation programming unit, type LB1

## Vitovent 200-C

Vitovent 200-C is a compact and affordable appliance for residential units in apartment buildings, separate annexes and existing buildings.

The unit has a maximum air flow rate of 200 m<sup>3</sup>/h and is designed for ventilation of living spaces measuring up to 120 square metres.

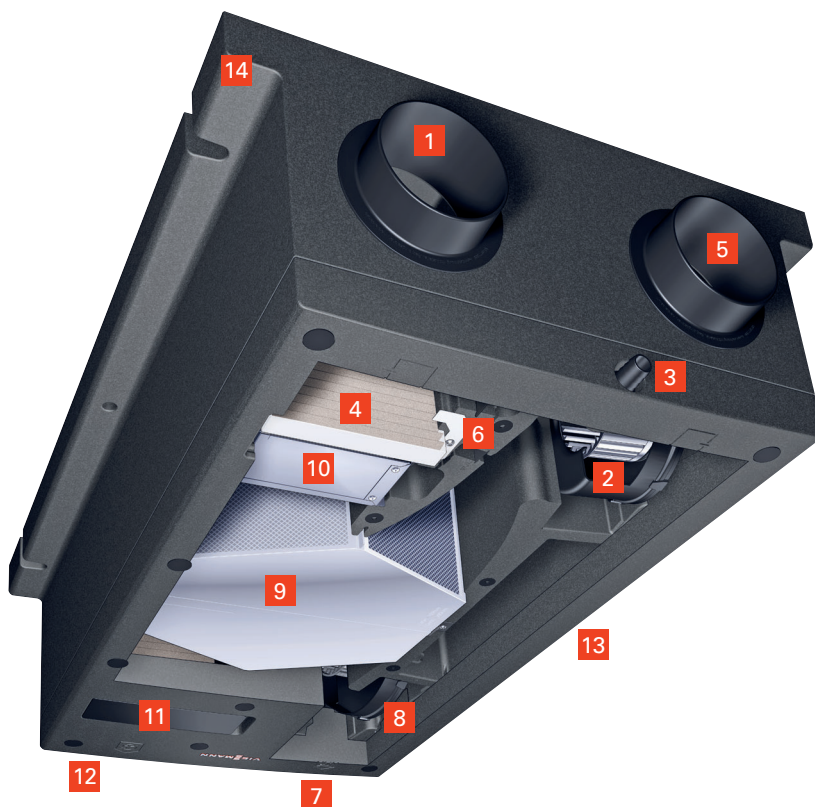

### VITOVENT 200-C

- 1 Outdoor air
- 2 Radial DC fan – extract air
- 3 Condensate pan and drain
- 4 Outdoor air filter
- 5 Exhaust air
- 6 Slot for preheating coil (accessory)
- 7 Supply air
- 8 Radial DC fan – supply air
- 9 Countercurrent heat exchanger
- 10 Bypass
- 11 Extract air filter (with cover)
- 12 Extract air
- 13 Terminal area
- 14 Integral fixing rails

### BENEFITS AT A GLANCE

- + Flexible use due to right and left-handed versions
- + Compact ventilation unit with an installed height of just 30 cm
- + Suitable for wall or ceiling mounted installation
- + Inexpensive step switch for easy operation
- + Modulating bypass for passive air tempering and frost protection in winter
- + Enthalpy heat exchanger (optional)

For specification, see page 57



Ventilation programming unit, type LB1



Step switch for easy operation



## Enjoy extra convenience, efficiency and sustainability in your home with Viessmann One Base

### Integrate all Viessmann systems and your Smart Home solutions in the new platform

Viessmann One Base gives you an easy, reliable and quick way to operate your entire energy system via app. The new platform bundles your devices and electronic applications into one single climate and energy solution for your home. You consume less energy, reduce your carbon footprint and stay on top of your costs at all times. Get your home in shape for a green future with Viessmann One Base!

### One system for everything: Viessmann One Base

The platform integrates any smart home solutions already in use, seamlessly and wirelessly. And you can easily add further services and devices as required, such as a new Wallbox for charging your electric car. Would you like to use power and heat even more sustainably and become part of the ViShare Energy Community\*? Viessmann One Base is compatible with all additional digital services. You can simply use voice assistants like Amazon Alexa and Google Assistant to control the services and devices integrated into the platform. With Viessmann One Base, you are equipping your home with an extendible, futureproof energy system that offers you long term prospects.

### VISSMANN ONE BASE

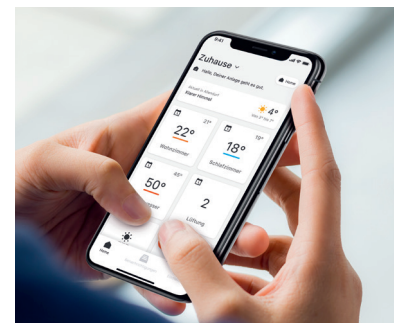

\* The operator and contractual partner of the ViShare Energy Community is Energy Market Solutions GmbH (EMS), a subsidiary of the Viessmann Group.



**Always in the best of hands**

All you need is the ViCare app – the integrated Viessmann Energy Management takes care of the rest. The app allows you to operate Viessmann One Base quickly and easily. Your contractor can also keep a remote eye on your system and address possible faults immediately by electronic means. You no longer have to arrange a time for your contractor to call and unnecessary travel is also eliminated. Leave your contractor to look after your system.

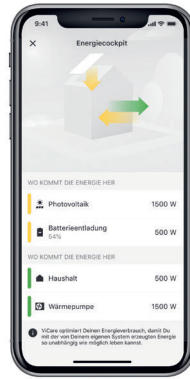

With the energy cockpit, end users can keep track of all the energy flows in their homes.

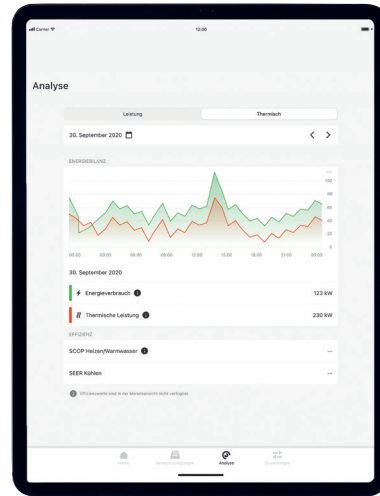

The energy balance visualises current and past energy flows. It documents the output of the whole system.

Applies for **Vitoair FS** with optional integration of a Vitocal heat pump (Viessmann One Base)



ViCare thermostatic radiator valves enable straightforward control of individual rooms via app or voice command, e.g. using Amazon Alexa.

**BENEFITS AT A GLANCE**

- + **Convenience:** You control your heating system via app and can connect the devices and services that you wish to use, such as Amazon Alexa, Apple HomeKit, Google Assistant and many more.
- + **Efficiency:** The platform links up and optimises energy flows for especially efficient and therefore cost effective operation.
- + **Reassurance:** Your heating contractor is automatically notified of any faults and can take corrective action before the situation gets out of hand.
- + **Sustainability:** Long-term integration of all required digital services, upgrades and product expansions, such as photovoltaics with a power storage unit and a Wallbox for e-mobility.



## One control unit for heat generator and mechanical ventilation unit

The Vitovent 300-W, 300-C and 200-C central ventilation units are especially easy to operate with Viessmann systems. These can be connected directly to the Vitocal heat pumps or Vitocaldens hybrid appliance. This creates a compact and futureproof central building services system.

Users thus benefit from the intuitive and standardised Viessmann control philosophy. The operation of the heating and ventilation systems is perfectly matched, and the cost of an additional programming unit is saved.

### Universal control unit for wall mounting

Independently of the ventilation control via the integral Vitotronic in the heat generator, all central mechanical ventilation systems can also be controlled using the LB1 universal

programming unit. This is easily fitted to the wall and connected to the Vitovent system using the cable provided.

Its benefits include:

- Large backlit graphic display with multi line plain text view
- High contrast, black & white depiction
- Context-sensitive help via the "?" button
- Storable presettings for individual day and seven-day programs
- 4-stage pushbutton
- Program selection
- Filter change indicator
- Connecting cable (6 m) included in the standard delivery

A simple step switch is also available for the Vitovent 200-C.

### BENEFITS AT A GLANCE

- + Standardised operation of all Vitocal heat pumps and central Vitovent ventilation units, also via ViCare app (end users) and ViGuide (trade partners)
- + Coordinated heating and ventilation operation
- + Cost savings from the use of only one control unit for two components
- + Shared use of system accessories
- + Attractive appearance
- + Excellent ease of use

## OPERATION OVERVIEW

### (Standalone operation)



Ventilation programming unit, type LB1



**VITOVENT 300-W**



**VITOVENT 300-C**



Step switch for easy operation



**VITOVENT 200-C**



Vitotrol 300-E (optional)



4-step switch with filter change indicator (optional)



**VITOAIR FS**

### (Integrated operation)

#### ViCare app



**VITOTRONIC 200**  
Type WO1C

Ventilation unit controlled using the Vitotronic 200 (type WO1C) in the heat generator



**VITOCAL 222-A**

#### ViCare app



#### VISSMANN ONE BASE



**VITOCAL 250-A**  
with Viessmann One Base

**Explanation in brief**

ViCare accesses the Vitoconnect online interface to control the heat generator. Once the system user has given their consent, the trade partner can use ViGuide to keep a constant eye on their customer's system.



Vitoconnect with sockets for the plug-in power supply unit and data connection

**5 year guarantee**

with system web connection/connectivity

For conditions, see [www.viessmann.de/garantie](http://www.viessmann.de/garantie)

**REASSURANCE**

Warmth and reassurance:

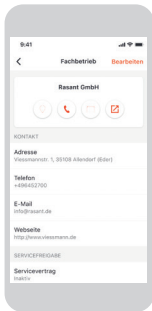

- + Green for go – see at a glance whether everything is OK
- + Be informed about a pending service
- + Direct access to the saved contact details of the contractor

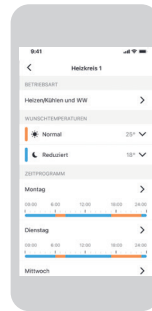

**ECONOMY**

Simply set your preferred temperature – save costs when you're away:

- + Straightforward, convenient operation of the heating system
- + Record your daily routine and automatically save energy costs
- + Set standard functions at the tap of a button on your smartphone

**ALL-INCLUSIVE SUPPORT**

A direct link to the trade partner – just in case:

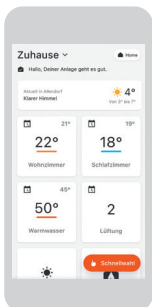

- + Simply enter the contact details of the trade partner
- + Quick and effective assistance – the contractor has all of the important information
- + All-inclusive support package for safety and maintenance



Download the app and tap "Discover ViCare" on the app's start screen – and off you go, with no need for an actual heat generator or internet connection.

# ViCare app

For central mechanical ventilation systems in conjunction with heat pumps

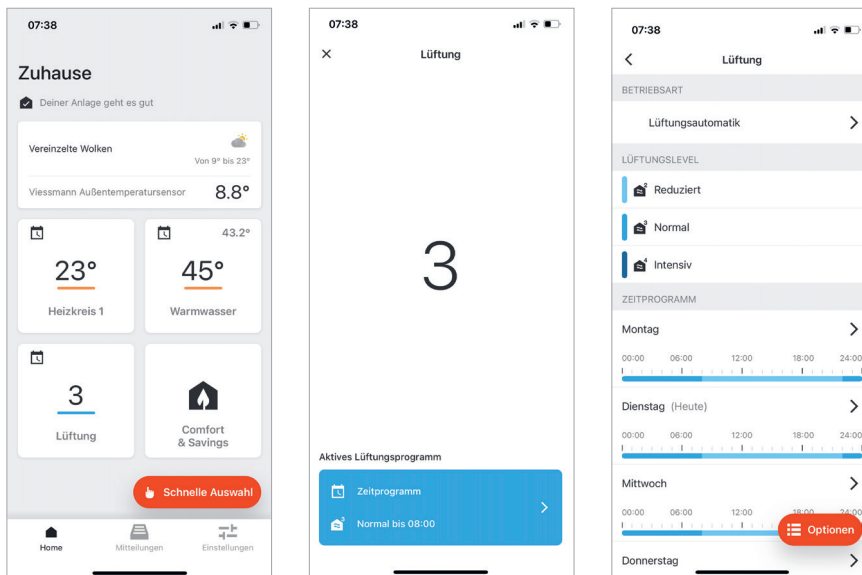

## BENEFITS AT A GLANCE

- + Simple operation of heat generator and ventilation unit via a central app
- + Adjust the ventilation stage from the sofa
- + Convenient configuration of time programs



## Vitoair click & go air distribution system

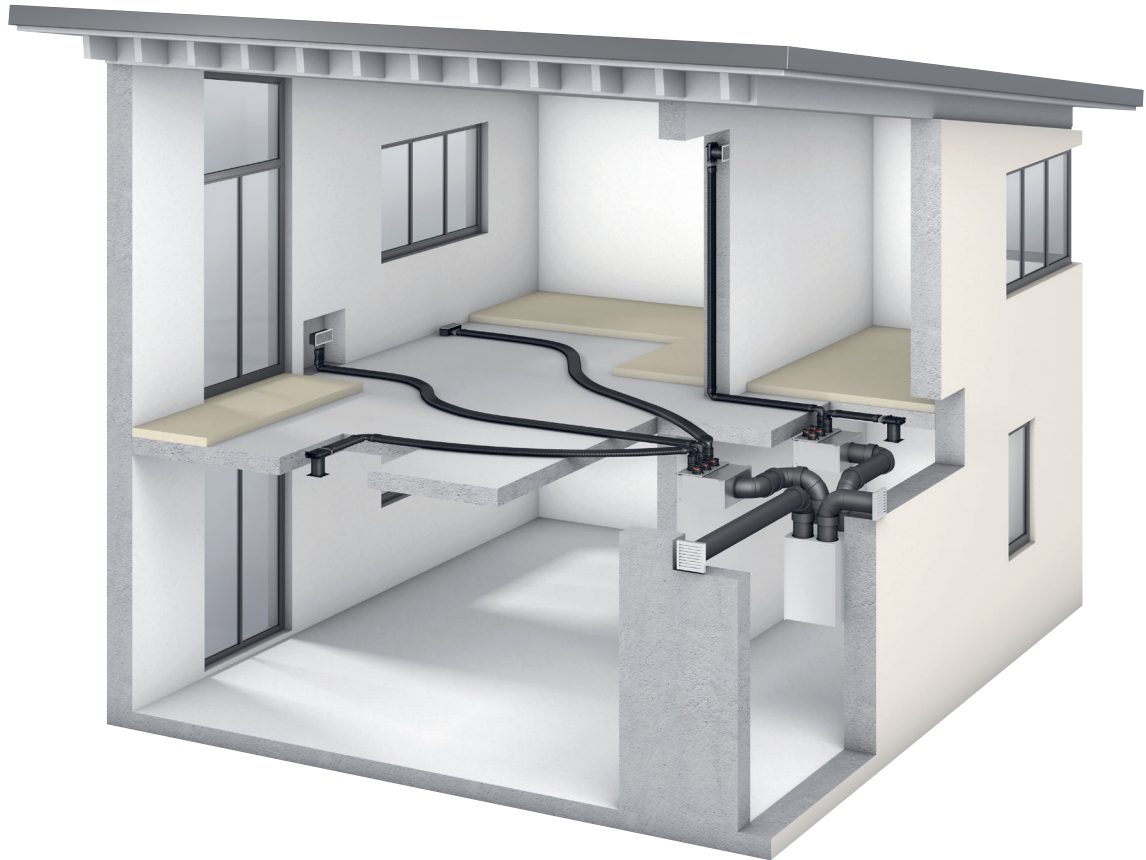

# Reliable distribution of supply and extract air inside the building

The air distribution system is the universal solution for all central Vitoair and Vitovent mechanical ventilation units. The system comprises just 19 multifunctional core components that can be flexibly combined.

## Straightforward design and routing

The flat duct system, which stands at a height of just five centimetres, can be routed directly on an unfinished floor. All parts are pushed together until they click permanently into place, without the need for tools. Round ductwork is available for routing the system in reinforced floors and in suspended ceilings. Adaptors allow easy connection.

This makes for quick installation of ductwork on the floor/ceiling after the initial construction of the building. Round ductwork should be designed

before initial construction begins. Regardless of whether flat or round ductwork is used, the flexible plastic distribution system can be routed universally in concrete.

## Diffusers in white or stainless steel finish

When deciding on inconspicuous covers for air diffusers, users have a choice of neutral white or a stainless steel finish.

## Smooth surfaces prevent deposits

Smooth inner and outer surfaces prevent contamination of the duct system, as well as the inlet and outlet vents. The air distribution system is totally hygienic. If required, the system can be easily cleaned via integral inspection ports.



Outdoor and exhaust air outlet (external view)



Roof outlet

## COMPLETE SERVICE FROM VIESSMANN

If required, Viessmann provides a wide range of engineering support services for the Vitovent systems:

- Calculation of air flow rates
- Calculation of the restrictors for presetting the individual air flow rates
- Design proposal for the flat duct system
- Precise routing instructions
- Commissioning
- Adjustment
- The fastest way to obtain a design: [www.schnelle-lueftung.de](http://www.schnelle-lueftung.de)

## BENEFITS AT A GLANCE

- + Clean, filtered air in the living space
- + Attractive air diffusers in white and stainless steel finishes
- + Hygienic air distribution
- + The duct system can be cleaned as necessary
- + Low pressure drop in the flat ductwork saves energy
- + Compact dimensions of components save space in the living area (in terms of ceiling height or wall thickness)
- + Comprehensive system accessories for virtually any application



**Click & go air distribution system**  
available as round or flat duct

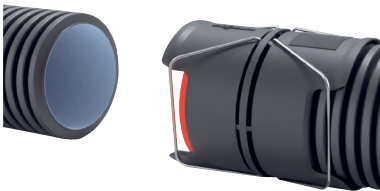

**Click & go air distribution system**  
Quick and safe installation thanks to integral gaskets and duct fixings

The new click & go air distribution system for central mechanical ventilation systems is exceptionally straightforward and safe to install. All components follow a standardised, flow optimised design concept.

#### **Visual check of secure connections**

The profiles come with their gaskets already in place, eliminating the time-consuming process of fitting them. A fixing bracket made of stainless spring steel on the profiles ensures a secure hold. Small parts such as gaskets and fixing materials do not end up lost or forgotten. And trade partners save a great deal of time.

All profiles have a viewing window. As the gasket stands out clearly from the profile and air duct by its colour, a defective connection can be easily spotted. You can tell that the connection is secure when the gasket has disappeared entirely into the profile

and can no longer be seen.

In the event of incorrect assembly at the construction site, the connection can be easily taken apart and securely reconnected without additional tools.

#### **Available as round or flat ducts**

Both the round and flat ducts are extremely flexible. Compared to conventional systems, they can be easily curved in tight bending radii. The new system is characterised by good impact resistance. The smooth, antistatic and antibacterial blue inner wall not only meets the strictest hygiene requirements, but also serves as a distinguishing feature.

The symmetrical 140 x 50 millimetre flat duct allows more air to be transported thanks to its flow-optimised, free air cross-section. It is suitable for installation in the floor structure, in the wall or a suspended ceiling, for new build and modernisation projects.

The required length can be quickly determined using the markings on the round and flat ducts.

Compatibility is assured between the round/flat duct and all of the components in the air distribution network.

#### **Simple process from design to installation**

The new web-based planning tool, the Vitoair Planner, makes it easy to design the system on almost any mobile device. Creating the building is an intuitive process that takes just a few clicks, and then you design the ideal mechanical ventilation system for it. The automatic compilation and integral pressure drop calculation ensure reliable planning. Once the design is complete, the materials required can be directly transferred to the online ordering system and ordered.

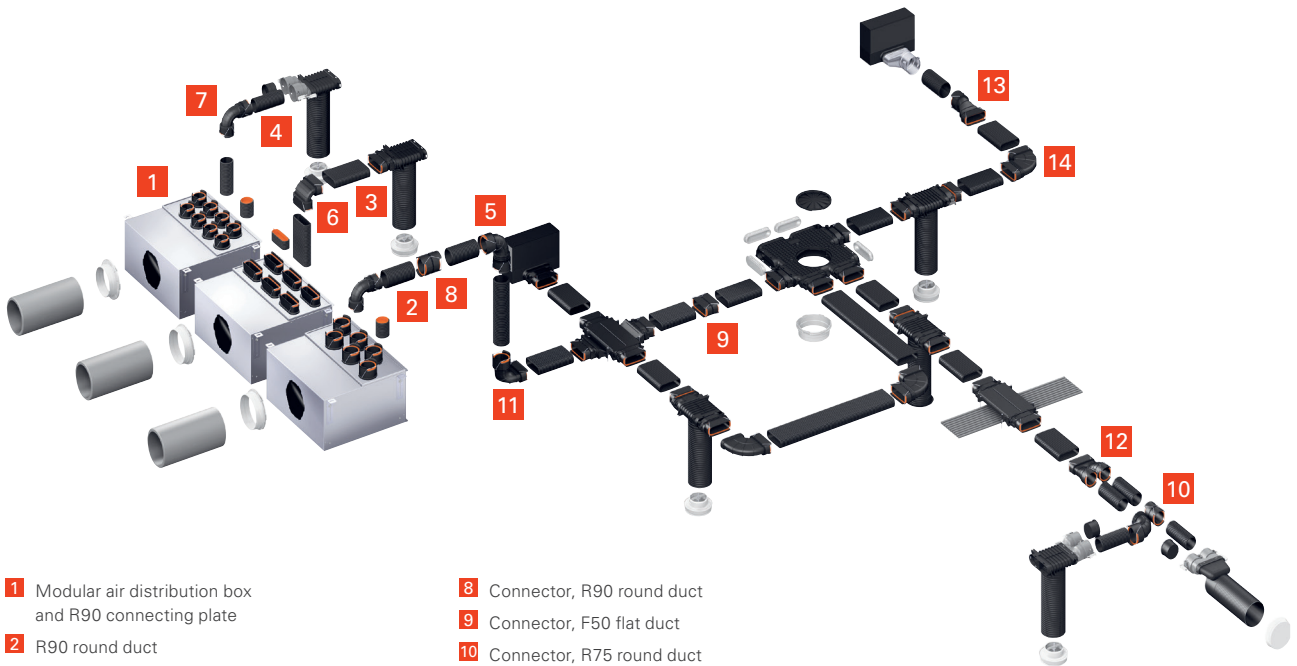

- 1** Modular air distribution box and R90 connecting plate
- 2** R90 round duct
- 3** F50 flat duct
- 4** R75 round duct
- 5** 90° bend R90
- 6** 90° bend, wide side F50
- 7** 90° bend R75

- 8** Connector, R90 round duct
- 9** Connector, F50 flat duct
- 10** Connector, R75 round duct
- 11** 90° bend R90/F50
- 12** Adaptor, flat duct to 2 x R75
- 13** Adaptor, flat duct to R90
- 14** 90° bend, narrow side

#### BENEFITS AT A GLANCE

- + Fast, secure, click & go installation thanks to integral gaskets
- + Viewing window for visible fault-free connections
- + Easy to cut to length thanks to printed markings
- + Flexible solutions for new build and modernisation projects
- + Fully compatible round and flat ducts and system components
- + Simple planning with Vitoair Planner
- + Flow optimised design for silent operation
- + Antistatic and antibacterial inner walls for highest standards of hygiene



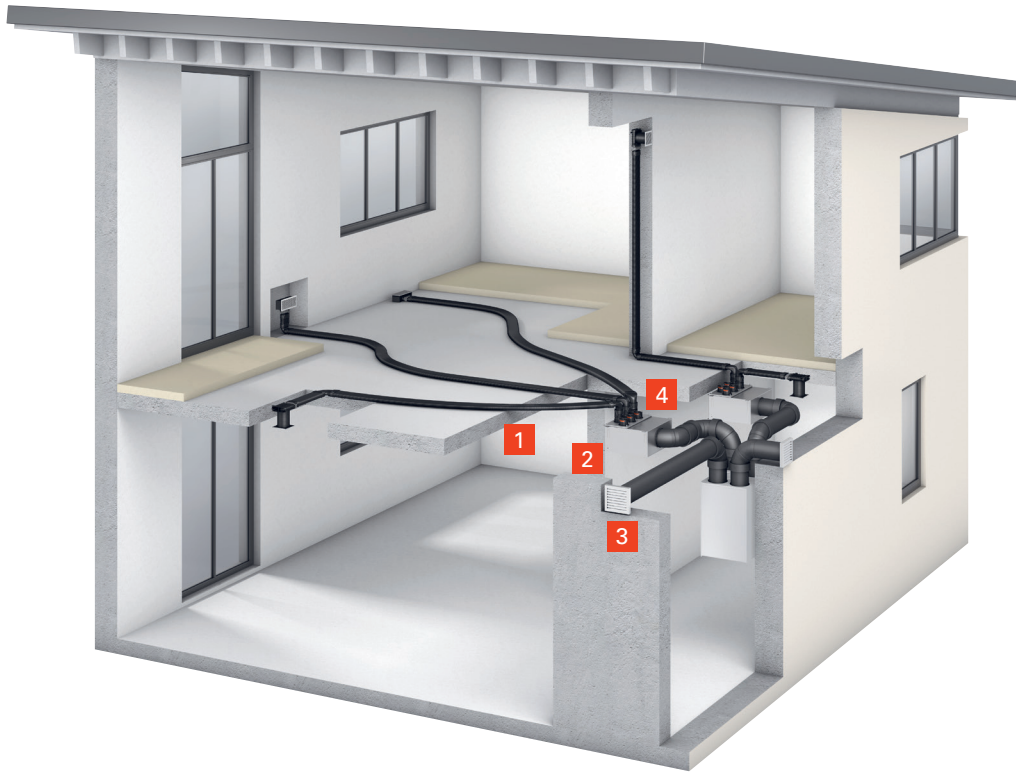

#### CENTRAL DISTRIBUTION IN THE FLOOR STRUCTURE

- F50 flat duct is installed in the compensating insulation of the floor structure
- Installation must be coordinated with sanitary and electrical systems (to avoid equipment conflicts)
- Static load on the building is minimal
- System can also be installed after completion of the concrete ceiling

#### DETAILS OF THE AIR DISTRIBUTION SYSTEM

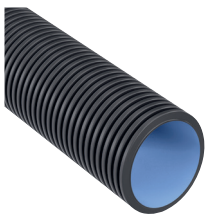

1 R90 round duct

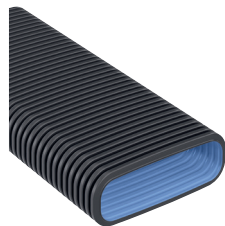

2 F50 flat duct



3 Modular air distribution box and R90 connecting plate



4 Bend R90/F50

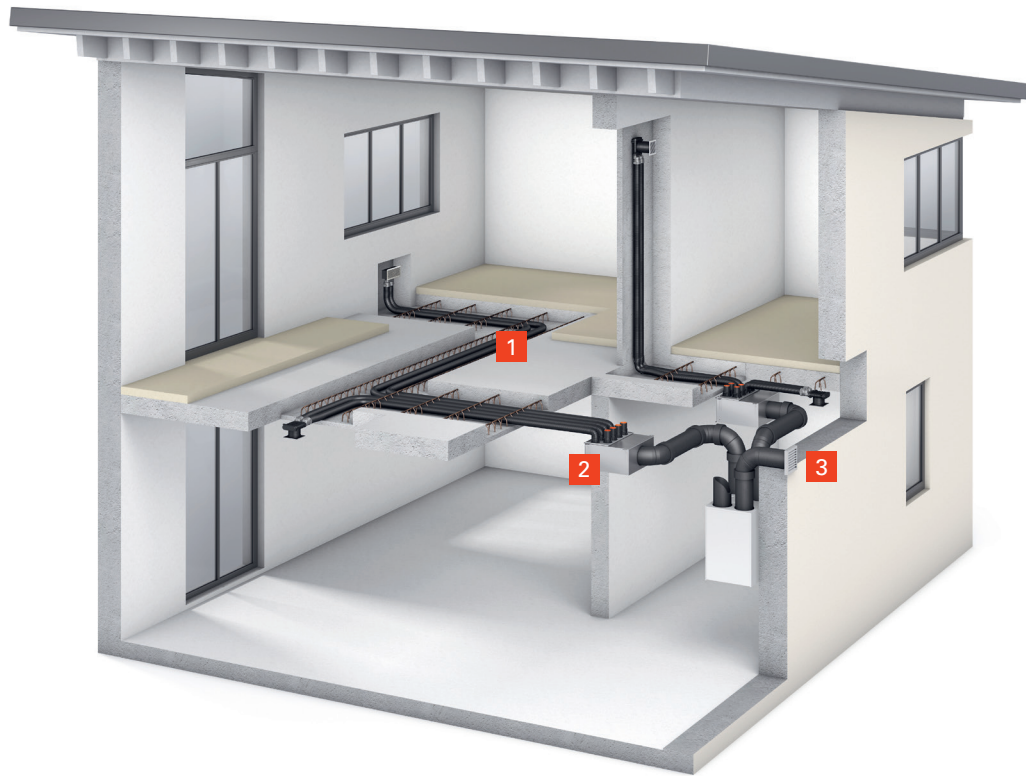

CENTRAL DISTRIBUTION IN A CONCRETE CEILING

- R75 round duct is installed in the concrete ceiling
- Low risk of conflicts with other pipes/cables through avoidance of screed installation
- Installation requires a static load assessment
- Very attractively priced air distribution system

DETAILS OF THE AIR DISTRIBUTION SYSTEM

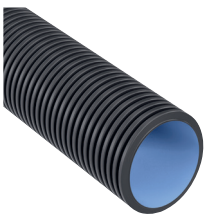

1 R75 round duct



2 Modular air distribution box and R75 connecting plate



3 External wall design cover in stainless steel

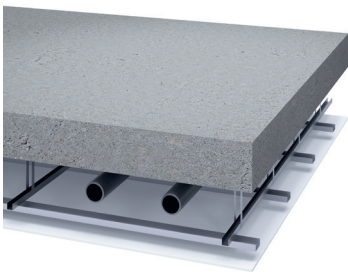
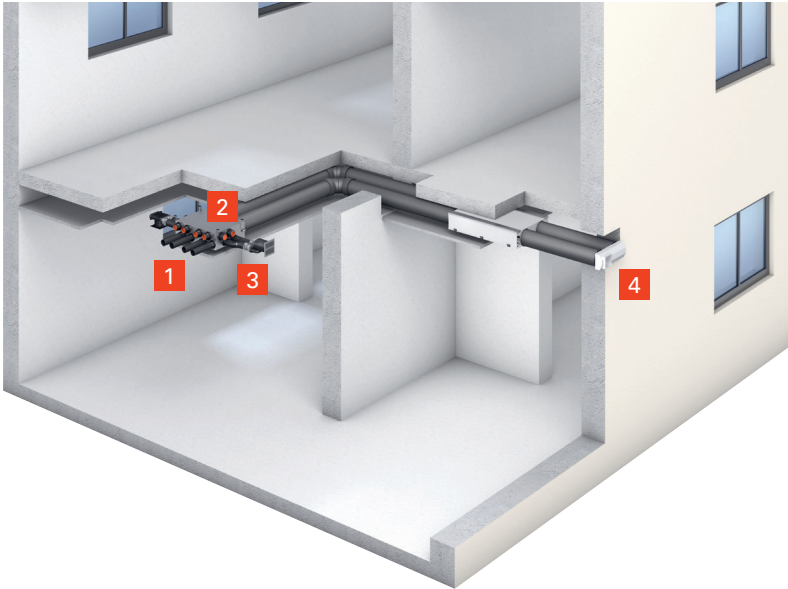

#### CENTRAL DISTRIBUTION IN A SUSPENDED CEILING

- Ventilation unit and distribution boxes are installed in the suspended ceiling
- Pipe distribution is possible with R75 round duct or F50 flat duct
- Ideal for modernisation and apartment buildings

#### DETAILS OF THE AIR DISTRIBUTION SYSTEM

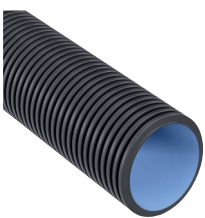

1 R75 round duct

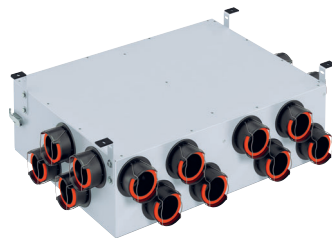

2 Air distribution box with silencing function



3 Valve connection, straight



4 Combination wall outlet



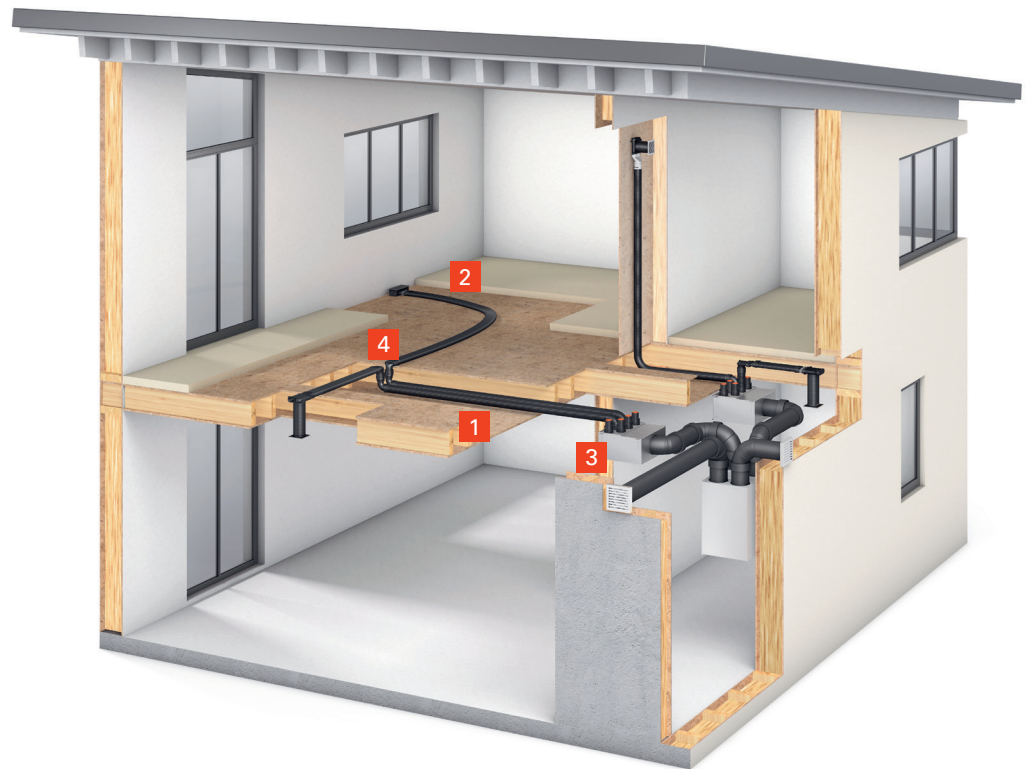

CENTRAL DISTRIBUTION IN A PREFABRICATED HOUSE

- System ideally suited to prefabricated houses with timber frame construction
- High degree of prefabrication due to routing in the walls and beam ceiling
- Low risk of conflict with other equipment due to fewer ducts in the screed area

DETAILS OF THE AIR DISTRIBUTION SYSTEM

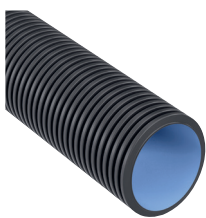

1 R90 round duct

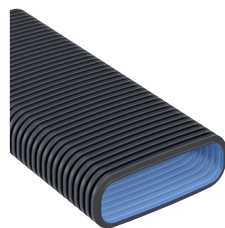

2 F50 flat duct



3 Modular air distribution box and R90 connecting plate



4 Bend R90/F50

### Comfort design covers

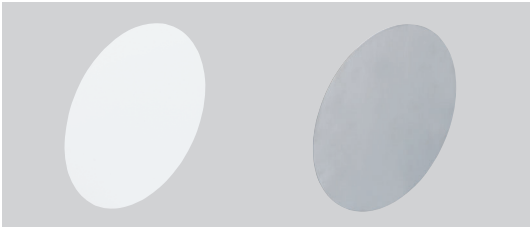

Supply and extract air design cover, round: in white and stainless steel finish



Supply and extract air design cover, square: in white and stainless steel finish

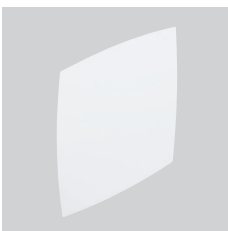

Supply and extract air design cover, rounded: white

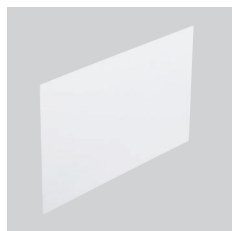

Supply and extract air design cover, rectangular: white

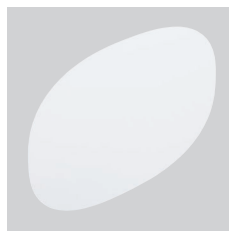

Supply and extract air design cover, elliptical: white

### Flat design covers

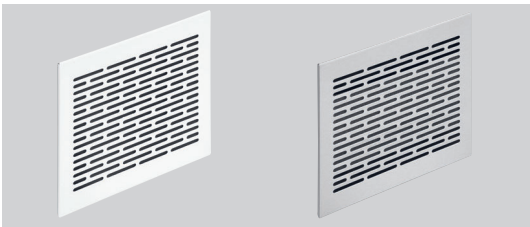

Supply and extract air cover: in white and stainless steel finish

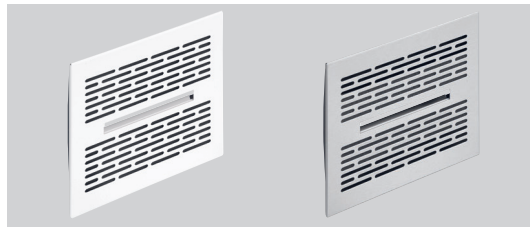

Wide-angle diffuser cover: in white and stainless steel finish

### Basic disc valve



Supply and extract air vent: white



Extract air vent: white

### Kitchen extract air vent

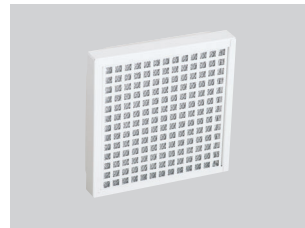

Kitchen extract air vent: metal, painted white

## Wall diffuser

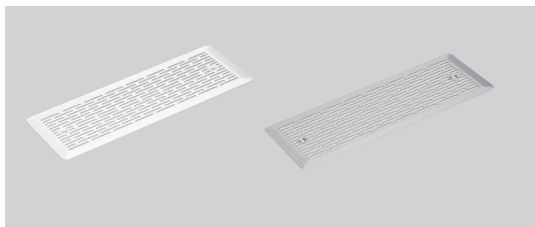

Wall diffuser cover grille: in white and stainless steel finish

## Floor diffuser



Floor diffuser cover grille: stainless steel

## Wall outlets



External wall cover: white



External wall outlet: stainless steel

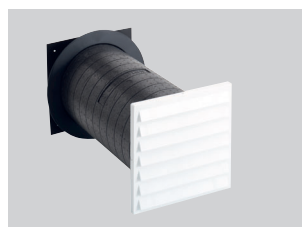

External wall outlet with weather grille



Combined outdoor and exhaust air outlet

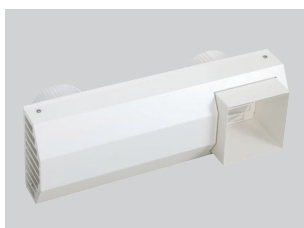

Combined outdoor and exhaust air outlet for the Vitovent 200-C and Vitovent 300-C



Outdoor/exhaust air extension

## Roof outlets



Roof outlet: black and terracotta



Stainless steel roof outlet (pitched roofs only)

**VITOVENT 200-D**

Controlled ventilation of individual rooms with heat recovery

Max. air flow rate:

55 m<sup>3</sup>/h

Heat recovery level:

up to 90 %

[Page 38](#)

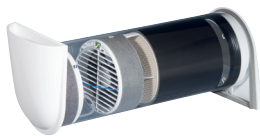
**VITOVENT 100-D**

Decentralised ventilation with heat recovery

Max. air flow rate:

46 m<sup>3</sup>/h

Heat recovery level:

up to 91 %

[Page 41](#)

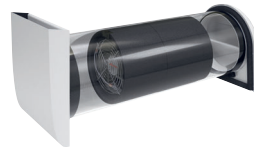
**VITOVENT 050-D**

Decentralised ventilation with heat recovery

Max. air flow rate:

43 m<sup>3</sup>/h

Heat recovery level: up to

90 %

[Page 42](#)

**VITOVENT 200-P**

Floorstanding ventilation system with displacement principle

Max. air flow rate:

800 m<sup>3</sup>/h

Heat recovery level: up to

96 %

[Page 50](#)



# Decentralised mechanical ventilation systems

Decentralised ventilation with heat recovery not only ensures the necessary minimum air change rate. By recovering heat from the extract air and transferring it to the cold incoming outdoor air, less heating energy is required. This in turn reduces heating costs and protects the environment. Energy is used in a very efficient way.

## **Uncomplicated installation without duct system**

One of the selling points of these units is their simple installation. Decentralised ventilation units can be installed in specific individual rooms. There is no need to install an air distribution system.

All that is required for straightforward installation is a wall outlet or a hole through the external wall of the respective room and a 230 volt power supply. Residential units can be equipped with several units that operate independently of each other.

## **Continuous and alternating systems**

Decentralised ventilation units are divided into two types of system: continuous and alternating.

In systems that operate continuously, the ventilation unit has two fans: one for supply air and one for extract air. Heat recovery is ensured by a cross-countercurrent heat exchanger. Optimum ventilation of individual rooms is achieved with units in continuous operation.

In alternating ventilation systems, each ventilation unit has only one fan, so they can only be used in pairs. While one unit is in supply air mode, the other unit handles the extract air. After 70 seconds the air direction changes. An integrated ceramic heat exchanger stores the extract air energy and transfers it to the supply air after the change of direction. This system is suitable for ventilating entire residential units. See further details on page 40.

## **BENEFITS OF DECENTRALISED MECHANICAL VENTILATION**

- Consistently good room climate through ventilation
- Energy saved through efficient use of heat
- Protection against mould growth and moisture damage

## Vitovent 200-D

The compact Vitovent 200-D mechanical ventilation unit has been designed for the controlled ventilation of individual rooms. The incoming air is filtered and heated via the cross-countercurrent heat exchanger with the heat extracted from the indoor air. Up to 90 percent of the heat latent in

the extract air is recovered. Up to 55 cubic metres of air is replaced per hour. Complete ventilation concepts can be achieved by utilising several units.

The installation of the ventilation unit requires only one opening in the external wall. Additional air ducts are not required. A single power supply is enough (230 volts). A choice is available between angular and rounded casing designs for high flexibility plus quick and easy installation.

### VITOVENT 200-D

- 1** External wall cover
- 2** Cross-countercurrent heat exchanger
- 3** DC fan (outdoor/supply air)
- 4** Extract air filter
- 5** Casing made from expanded polypropylene (EPP)
- 6** Internal wall cover
- 7** Programming unit (on the right-hand side)

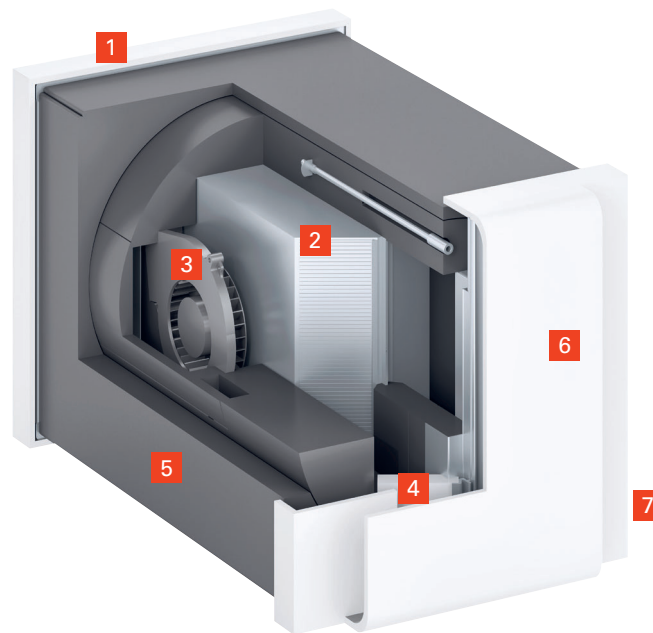

### BENEFITS AT A GLANCE

- + Ideal for the ventilation of individual rooms
- + A room without external walls (e.g. bathroom, WC) can be ventilated at the same time (adjacent room connection)
- + Use of a single unit in extract air areas possible
- + Integral preheating coil (accessories)
- + Ideal for allergy sufferers, thanks to filtered outdoor air with pollen filter as standard
- + Optional air quality sensor for automatic operation (only type HRM/HRV)



Wireless operating switch (accessory)

For specification, see page 58

# Installation options

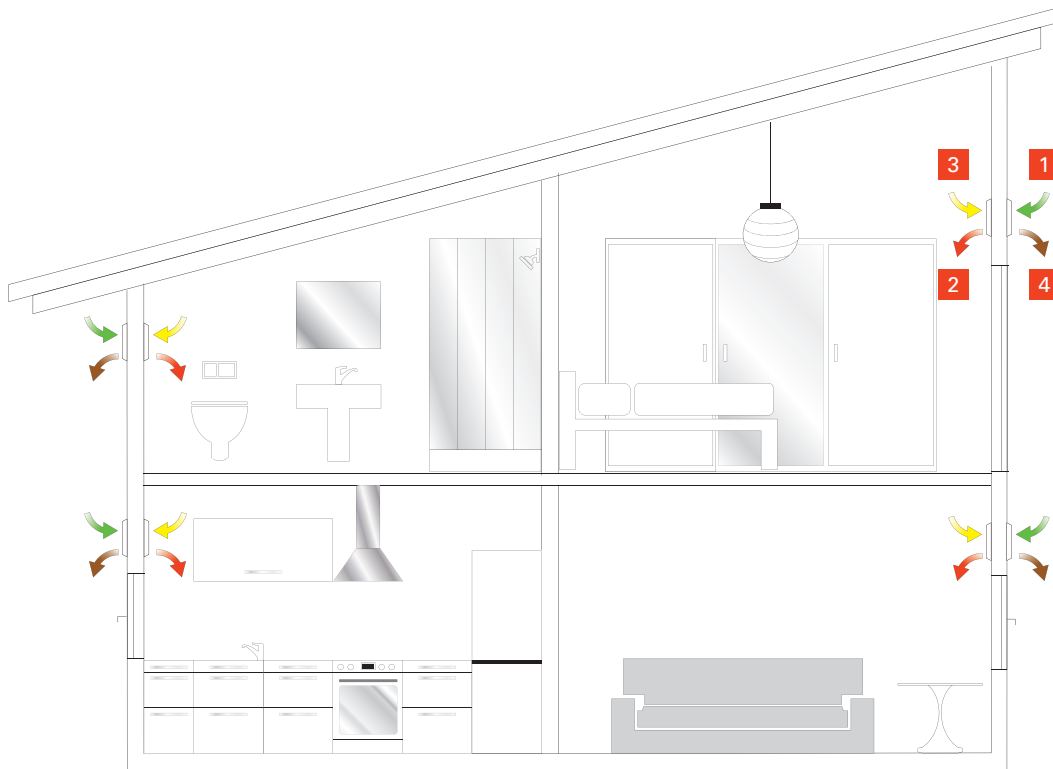

- 1 Outdoor air
- 2 Supply air
- 3 Extract air
- 4 Exhaust air



Round wall sleeve with external wall cover



Square wall sleeve with external wall cover

## Alternating ventilation system for the most demanding requirements

A supply/extract air system with alternating units is the ideal solution when energy efficiency and comfort requirements are very high. In the living space (such as the living room and bedrooms), the alternating ventilation units are installed in the external wall. The ventilation units can either ventilate individual rooms (the living room/dining room/kitchen) or a group of rooms (the parents' and children's bedrooms). The integral ceramic heat exchanger reduces energy losses and increases convenience.

### Automatic control in different zones

The intelligent touch programming unit (accessory) allows the residential unit to be divided into different zones. Furthermore, automatic demand control by means of an optional humidity and temperature sensor is possible.

### Unobtrusive installation in window reveal

Ventilation in the window reveal is also possible for the highest level of sound insulation and an unobtrusive appearance. The Vitovent 100-D type E100 or type E200 extract air fans are used for extract air areas (e.g. bathrooms) that have an external wall, while the Vitovent 100-D type E300 discharges the air to the outside via a central line. In addition to the standard external wall cover in white, versions with a stainless steel finish are also available.

Alternatively, a Vitovent 200-D can also be installed in the extract air areas for the use of heat recovery.



- 1** Alternating unit
- 2** Extract air fan, type Maico ER-EC
- 3** Extract air fan with humidity module, type Maico AWB 100-HC



Ventilation in the window reveal



Extract air fan with humidity module, type Maico AWB 100-HC



Extract air fan, type Maico ER-EC



# Vitovent 100-D

Vitovent 100-D is a decentralised ventilation system. A hole through the external wall and a 230 volt power supply are required for installation. This makes it ideal for modernisation and use in apartment buildings. The continuous operation of the

ventilation system guarantees constant air exchange in the rooms, while at the same time regulating the relative humidity. At least two Vitovent 100-D operate in alternating mode. Whilst one unit blows fresh air into the room, the other removes the stale air to the outside. The heat latent in the stale air

heats up the integral ceramic thermal store. Around 70 seconds later, the rotational direction of both fans changes and the waste heat that has been stored is transferred to the fresh supply air.

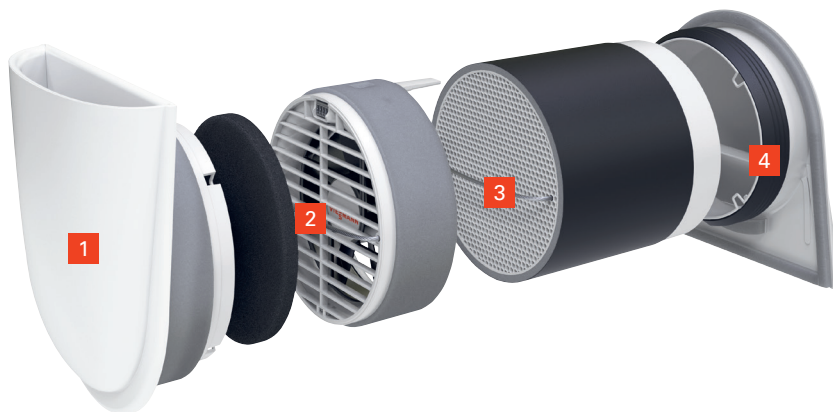

## VITOVENT 100-D

- 1 Flow and sound-optimised internal wall cover (multi-layer silencer)
- 2 Reversible fan
- 3 Thermal store
- 4 External wall cover

## BENEFITS AT A GLANCE

- + Easy installation with standard Ø 162 mm drilled hole
- + Wiring with a star or ring configuration and encoded connections with no risk of mix-ups
- + Unobtrusive appearance and high sound insulation against outside noise with window reveal installation set
- + Internal and external wall covers optimised for noise and flow
- + Airing mode for air tempering on cool summer nights
- + Optional humidity and temperature control for demand-dependent control in up to three zones
- + Easy operation via touchscreen, LED programming unit or app

For specification, see page 59



Controller with touchscreen

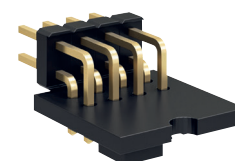

Humidity and temperature sensor for installation in the internal wall cover

## Vitovent 050-D

The Vitovent 050-D decentralised ventilation unit is designed for a maximum air flow rate of 43 m<sup>3</sup>/h. It is equipped with a heat exchanger unit (ceramic storage block) for heat recovery. This compact unit is integrated in the external wall (standard 162 millimetre drilled hole) and requires a 230 volt power supply.

The units are used in pairs for the ventilation of individual or multiple rooms in residential buildings.

Air is drawn into the building via the fan of one ventilation unit (supply air mode), while the second ventilation unit channels air out of the building (extract air mode).

Depending on the ventilation stage, the units swap their air flow direction simultaneously after 70 seconds.



### VITOVENT 050-D

- 1 Internal wall cover
- 2 Filter
- 3 Reversible fan
- 4 Ceramic thermal store
- 5 External wall cover

### BENEFITS AT A GLANCE

- + Energy cost savings through heat recovery
- + Reliable moisture protection without having to frequently open windows
- + Airing mode for cooling during warm summer nights
- + Easy installation with standard Ø 162 mm drilled hole
- + Straightforward installation with set for unfinished walls and completion set
- + Simple operation with large buttons or rotary controller
- + Star wiring configuration and anti-twist connections
- + Tool-free maintenance from the living space

For specification, see page 60



Control via programming unit with large buttons



## Vitovent 100-D and 050-D external wall covers



External wall cover: white and anthracite

### PRODUCT FEATURES

- Noise and flow-optimised two-layer external wall cover (white), reduces draughts
- Compatible with the Vitovent 100-D



External wall cover: white

### PRODUCT FEATURES

- External wall cover (white), reduces draughts
- Compatible with the Vitovent 050-D



External wall design cover: stainless steel

### PRODUCT FEATURES

- External wall cover (stainless steel), reduces draughts



External wall cover: stainless steel

### PRODUCT FEATURES

- External wall cover (stainless steel), reduces draughts



## Vitovent 100-D and 050-D window reveal



Installation element for window reveal

### PRODUCT FEATURES

- Unobtrusive appearance and high sound insulation against outside noise
- External grille, reduces draughts



## Programming units for the Vitovent 100-D



Touchscreen programming unit

### PRODUCT FEATURES

- Convenient touch operation with sleep and airing modes
- Individual control of up to 3 ventilation groups
- Max. number of units depends on the number of power supply units
- Filter change indicator
- Programming unit
- Wall frame
- Ring or star wiring configuration



LED programming unit

### PRODUCT FEATURES

- Operation via buttons with sleep and airing modes
- Max. number of units depends on the number of power supply units
- Filter change indicator
- Programming unit
- Wall frame
- Star wiring configuration

## Programming units for the Vitovent 050-D



Rotary controller

### PRODUCT FEATURES

- Programming unit with clear and simple design
- Filter change indicator
- Wall frame
- Connection of up to 6 Vitovent 050-D
- Star wiring configuration



Programming unit

### PRODUCT FEATURES

- Programming unit with clear structure and simple selection of all operating modes
- Integral humidity sensor
- Filter change indicator
- Wall frame
- Connection of up to 6 Vitovent 050-D
- Star wiring configuration

## Programming units for the Vitovent 100-D and 050-D



### PRODUCT FEATURES

- Control of the ventilation unit via the WiFi programming unit or via an app (see below)
- Integral temperature, humidity and VOC sensor
- Voice control compatible
- wibutler compatible

## Vitovent D app for Vitovent 100-D and 050-D with WiFi

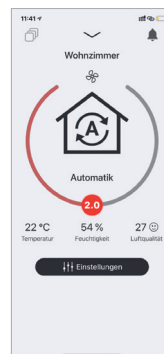

### PRODUCT FEATURES

- Control the ventilation stage
- Define time programs
- Filter change indicator
- Assign the zones
- Visualise the sensor data



## Effective health protection – air purification and ventilation system in a single unit

The effectiveness of ventilation systems has become a hot topic since the start of the coronavirus pandemic. Not only does the Vitovent 200-P ventilation unit reduce the viral load in aerosols, it also lowers the CO<sub>2</sub> load in closed rooms. It ensures optimum indoor air quality at all times, even in exceptional circumstances, and offers the best solution for occupied spaces with up to 30 people.

### **The displacement principle: clean air for everyone**

The virtually silent air supply is based on the displacement principle. This means that everyone in the room benefits from an individual air flow from a pool of fresh air. Convection causes this air to move directly to the breathing zone. Exhaled aerosols rise to the ceiling, where they are removed by the ventilation unit.

### **Meets TÜV Rheinland criteria**

After testing by TÜV Rheinland, the Vitovent 200-P was confirmed as compliant with the structural and hygiene requirements of VDI 6022-1 for ventilation and air conditioning systems.

# Optimal infection control for medical practices



Especially at times of high infection risk, it is not easy to guarantee normal patient care. Organisational measures alone are not sufficient – not least because direct contact between people is both unavoidable and essential. Notwithstanding this, one thing is of the utmost importance: the health of patients and medical personnel.

## Advanced system for effective infection control in enclosed spaces

The coronavirus and influenza bugs spread mainly via tiny aerosols in our breath. This presents a health risk which is drastically increased in closed rooms, such as waiting rooms or treatment rooms. Simply airing a room is not enough to combat this hazard. That is why the Vitovent 200-P ventilation

system combines two measures: the purification of indoor air and the supply of fresh outdoor air. This significantly reduces the risk of infection:

- + HEPA filters create almost perfectly purified indoor air
- + Low CO<sub>2</sub> concentration
- + Fresh and clean air in all areas of enclosed spaces

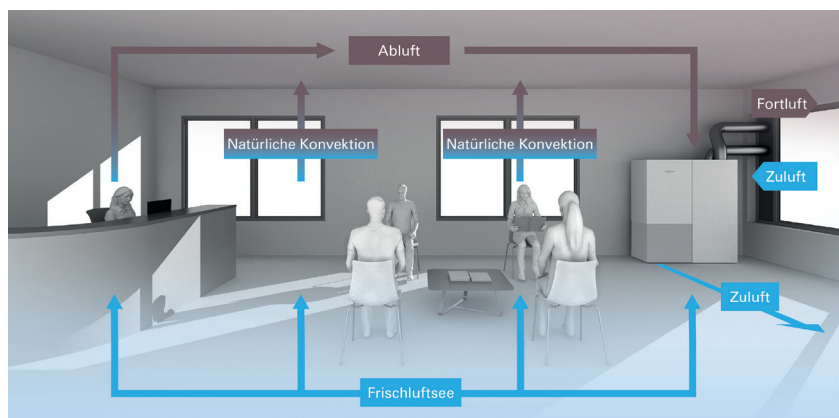





## Top marks for health – infection control in schools



Schools play an important role in our society. Classroom-based teaching is essential for our children's development, and parents can only work when the schools are open. Notwithstanding this, one thing is of the utmost importance: the health of pupils and teachers.

### Fresh air from outside

It is often difficult to ventilate classrooms well. Yet there is a high risk of infection from the aerosols that we breathe in and out. Regular air exchange and a controlled supply of fresh air are therefore key to

minimising this risk. The intelligent sensor technology of the Vitovent 200-P constantly measures the CO<sub>2</sub> concentration in the room and adjusts the air volume as required.

### Filtered indoor air

The Vitovent 200-P from Viessmann is a compact ventilation system that combines the supply of fresh air with

efficient filtering of the remaining indoor air. The HEPA (high efficiency particulate air) filters used even capture particles that measure less than one micrometre. For comparison: a strand of human hair is 100 micrometres in diameter, while aerosols are up to five micrometres in size.

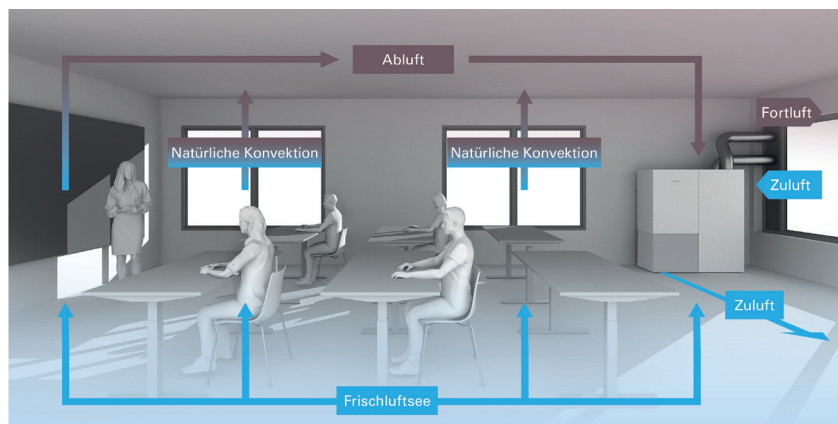

The Vitovent 200-P ventilation system continuously supplies purified, fresh air for up to 30 people per room based on the displacement principle (depending on the room setup).



## Best means of infection control in nurseries

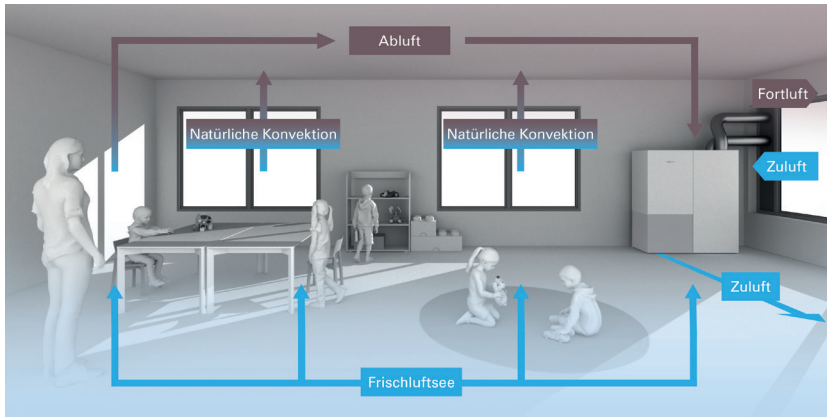

Fresh indoor air and a pleasant room climate for children and nursery staff

Nurseries are very important for our communities. Playing together and spending time with others of the same age are essential for our children's development, and parents can only work when nurseries are open. Notwithstanding this, one thing is of the utmost importance: the health of children and nursery staff.

### Protection for children and nursery staff: the innovative ventilation system from Viessmann

"We create living spaces for generations to come" reflects the responsibility that Viessmann assumes in society. COVID-19 has now given even greater importance to this commitment. Viessmann has developed an innovative and efficient concept for optimum air hygiene in nurseries.

### Subsidies of up to 80 percent for the Vitovent 200-P

Since 11 June 2021, it has been possible to apply for a subsidy for installing new stationary ventilation and air conditioning systems. As early as April 2021, the federal subsidy was amended to include coronavirus-related modifications and upgrading of precisely these systems. The aim of this is to encourage investment in this area. This is because rooms which are highly frequented with a

large fluctuation in numbers of people are a high infection risk. This risk can be lowered significantly by installing a Vitovent 200-P.

### Who is eligible to apply?

The subsidy focuses on facilities for children under twelve. These include nurseries and child daycare centres as well as kindergartens and primary schools. Those who are eligible to apply must meet the terms stated in Section 33 Nos. 1 and 2 of the German Protection against Infection Act.



The risk of infection is particularly high in enclosed spaces with direct personal contact.

## Vitovent 200-P



The effectiveness of ventilation systems has become a hot topic since the start of the coronavirus pandemic. Not only does the Vitovent 200-P ventilation unit reduce the viral load in aerosols, it also lowers the CO<sub>2</sub> load in closed rooms. The result is optimum indoor air quality at all times, even in exceptional circumstances. Vitovent 200-P has been developed especially for schools, seminar rooms and kindergartens.

### **Plug & play for effective infection control**

Vitovent 200-P combines two functions: it cleans the indoor air and at the same time supplies the room with fresh outdoor air. The following

features contribute to reducing the risk of infection and achieving a healthy room climate:

- HEPA filter removes 99.99 % of all viruses
- Low CO<sub>2</sub> concentration
- Fresh and clean air evenly distributed throughout the room

A 230 volt socket is all you need to operate the Vitovent 200-P. The plug and play system can be set up in a short time, and as a standalone unit it is ideal for retrofitting, e.g. in classrooms. Connecting the fresh air and exhaust air ducts requires the replacement of only one window element.

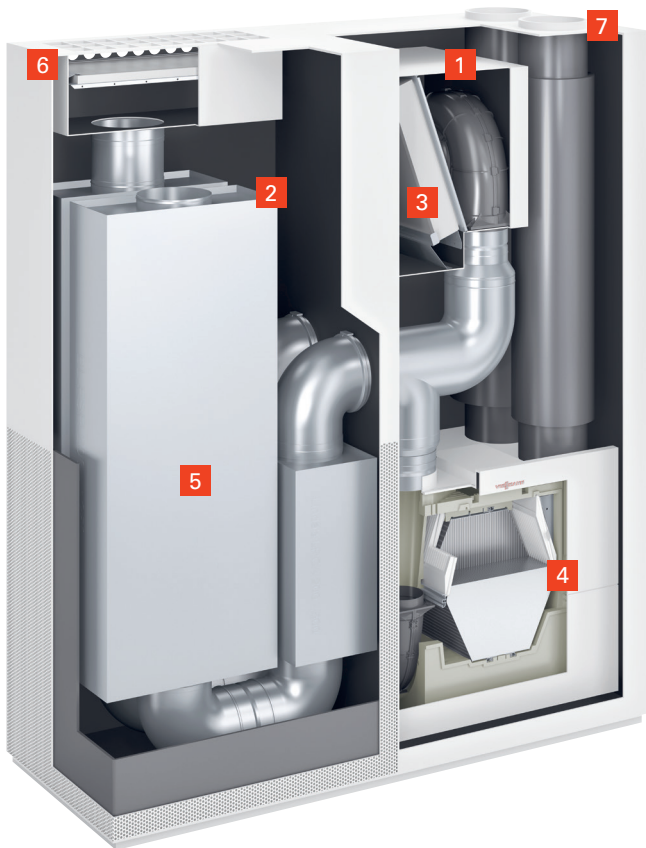
**VITOVENT 200-P**

- 1 Ventilation module
- 2 Supply/extract air module
- 3 HEPA filter unit
- 4 Integral ventilation unit
- 5 Silencer unit
- 6 Extract air unit
- 7 Outdoor and exhaust air connectors

**BENEFITS AT A GLANCE**

- + 99.99 % filtration of viral aerosols by HEPA filters
- + Dual operating mode combines the supply of fresh air with indoor air filtering
- + Displacement principle ensures that fresh air is available exactly where it is needed
- + Even, draught-free air distribution and quiet operation provide for a pleasant room climate
- + Integral sensors enable demand-dependent control based on the CO<sub>2</sub> concentration
- + Heat recovery principle reduces heating bills and is good for the environment
- + Plug & play concept for simple installation – ideal for quick retrofitting
- + Ventilation that works regardless of the building structure – even in rooms with windows that cannot be opened

For specification, see page 61

## Vitoair Planner – plan and order directly

The new Vitoair Planner allows quick project planning of a mechanical ventilation system. The building structure with all rooms is mapped in just a few steps and a ventilation concept is created according to DIN 1946-6. It is also possible to enter the flow rates manually. The tool then defines the appropriate system including the ventilation unit and duct type.

The clear air flow rate plan allows the trade partner to adjust duct lengths and the choice of accessories. Automatic pressure drop calculation guarantees reliable planning at all times.

The detailed project report includes the air flow rate plan, all the information needed for commissioning and the recommended restrictor settings. An illustrated material list is also created. This is then used as a basis for generating a quotation with the respective partner discount directly in the Vitoair Planner. Finally, the order can be placed immediately in the Viessmann Shop.

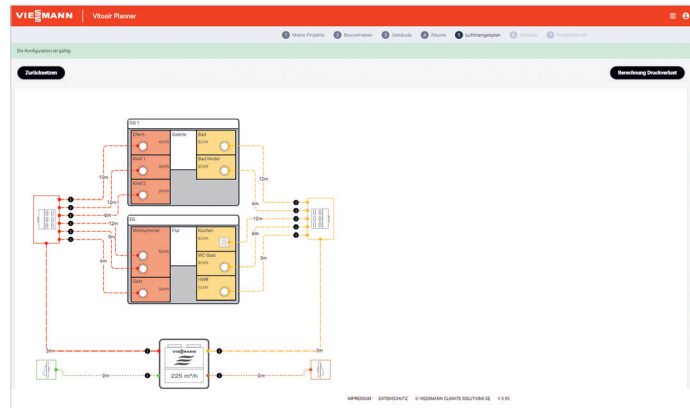

**Vitoair Planner**  
vitoair-planner.viessmann.com

### BENEFITS AT A GLANCE

- + Quick and easy planning
- + Ventilation concept to DIN 1946-6 or manual input of flow rates
- + Individual matching to the respective project
- + Reliable planning through automatic pressure drop calculation
- + Air flow rate plan with all information relevant for installation
- + Project report with illustrated list of materials and commissioning information
- + Quotation with partner discount generated directly in the design tool
- + Direct ordering in the Viessmann Shop

The rapid route to a quick design – [www.schnelle-lueftung.de](http://www.schnelle-lueftung.de)

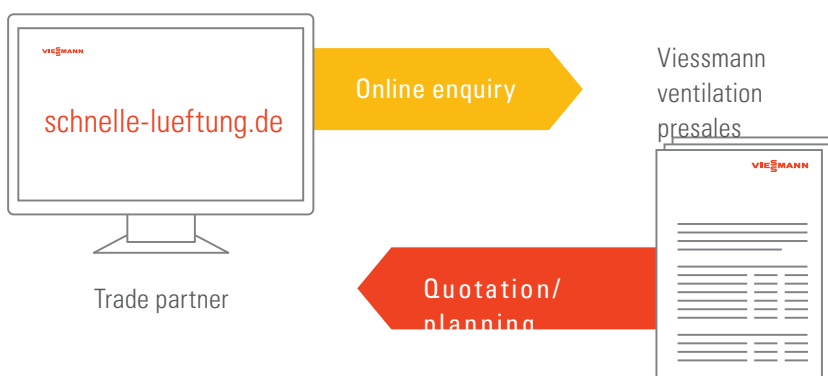

If you need support with ventilation planning, the rapid ventilation planner is now available as a digital request tool



## Durable in use – easy to maintain

Mechanical ventilation systems need servicing from time to time, just like any other technical equipment. Only systems which are regularly maintained ensure consistently high indoor air quality through the filtering of dust and pollen.

### **Straightforward servicing by the operator**

Viessmann mechanical ventilation systems are designed in such a way that operators can carry out essential service work themselves quite easily. This includes:

- Cleaning and changing of filters up to twice a year
- Resetting the status display for filter replacement
- Recognising fault messages on the control unit (such as the need for a filter change)

No additional accessories are required for this purpose. The service indicators can be checked conveniently via the ventilation unit remote control.

### **Maintenance by the contractor**

Scope and frequency depend ultimately on individual circumstances, such as location. In order to ensure consistent system quality, we recommend having the following steps taken every two years as part of an inspection by a qualified contractor:

- Filter changes at air diffusers and vents
- Heat exchanger cleaning
- Visual inspection of all air diffusers and vents

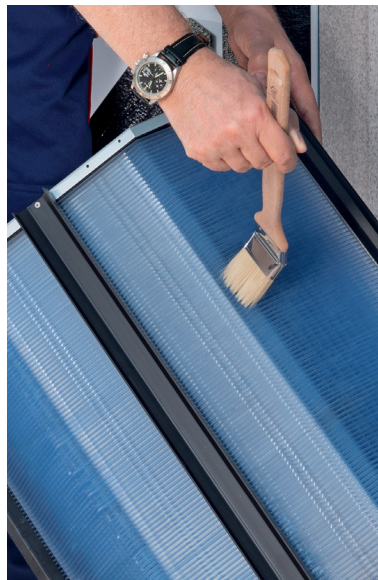

Straightforward servicing of the mechanical ventilation system (in this case the Vitovent 300-W): Visual inspection of the filters (top left) and filter replacement in the case of severe contamination. The heat exchanger can be cleaned with a brush, vacuum cleaner or jet spray.





## VITOAIR FS

<b>Type</b>		300-E
<b>Max. air flow rate up to approx.</b>	m <sup>3</sup> /h	300
<b>Max. external pressure drop at max. air flow rate</b>	Pa	215
<b>Interior up to approx.</b>	m <sup>2</sup>	280
<b>Dimensions (including mounting rail)</b>		
Length (depth)	mm	1254
Width	mm	808
Height	mm	248
<b>Weight</b>	kg	51.5
<b>Energy efficiency class</b>		
in acc. with Commission Delegated Regulation (EU) No 1254/2014		
– Manual control		A
– Time control		A
– Central demand-dependent control		A
– Control according to local demand		–
<b>Factory-set air flow rates</b>		
Reduced ventilation (stage 1)	m <sup>3</sup> /h	54
Standard ventilation (stage 2)	m <sup>3</sup> /h	126
Comfort ventilation (stage 3)	m <sup>3</sup> /h	180
Intensive ventilation (stage 4)	m <sup>3</sup> /h	234
<b>Setting range for the air flow rates</b>		
Reduced ventilation (stage 1)	m <sup>3</sup> /h	50 to 300
Standard ventilation (stage 2)	m <sup>3</sup> /h	50 to 300
Comfort ventilation (stage 3)	m <sup>3</sup> /h	50 to 300
Intensive ventilation (stage 4)	m <sup>3</sup> /h	50 to 300
<b>Air intake temperature</b>		
Min. (in conjunction with electric preheating coil)	°C	-20
Max.	°C	+40
<b>Ambient temperature</b>		
Min.	°C	+3
Max.	°C	+40
<b>Humidity</b>		
Max. relative room air humidity	%	70
Max. absolute extract air humidity	g/kg	12
<b>Filter class acc. to ISO 16890</b>		
Outdoor air filter (delivered condition/accessories)	%	ISO Coarse 60/ISO ePM1 50
Extract air filter (delivered condition)	%	ISO Coarse 60
<b>Heat recovery</b>		
Rate of temperature change to ErP	%	80
Heat recovery level to DIBt	%	80
Heat recovery level to PHI	%	80
Material, countercurrent heat exchanger/enthalpy heat exchanger		PETG
<b>Rate of humidity change to DIBt</b>	%	Up to 74
<b>Application areas</b>		
– New build		■
– Detached house		■

### Filter types to ISO 16890 – EN 779

G4 = ISO Coarse 60 %

F7 = ISO ePM1 50 %

**VITOVENT 300-W**

Type		H32S A225	H32S C325	H32S C400
<b>Air flow rate up to approx.</b>	m <sup>3</sup> /h	225	325	400
<b>Interior up to approx.</b>	m <sup>2</sup>	160	320	440
<b>Dimensions</b>				
Length (depth)	mm	455	560	560
Width	mm	600	750	750
Height	mm	650	650	650
<b>Weight</b>	kg	29.5	41.0	42.5
<b>Energy efficiency class</b>				
in acc. with Commission Delegated Regulation (EU) No 1254/2014				
– Manual control	⊕	–	–	–
– Time control	⊙	A	A	A
– Central demand-dependent control	⊖	A+	A+	A+
– Control according to local demand	⊕⊖	A+	A+	A+
<b>Type of heat exchanger</b>				
– Cross-counter-current		■	■	■
– Enthalpy cross-counter-current (accessory)		■	■	■
<b>Filter type</b>				
– Outdoor air filter (delivered condition/accessory)		G4/F7	G4/F7	G4/F7
– Extract air filter (delivered condition/accessory)		G4/G4	G4/G4	G4/G4
<b>Heat recovery</b>				
Rate of temperature change to ErP	%	92	91	92
Rate of temperature change to EN 308:1997	%	Up to 94	Up to 98	Up to 99
Heat recovery level to DIBt	%	92	91	92
Heat recovery level to PHI	%	89	91	90
Material, counter-current heat exchanger/enthalpy heat exchanger		PETG	PETG	PETG
<b>Rate of humidity change</b>	%	–	–	–
<b>System operation with Vitocal heat pumps</b>				
– Not possible with Viessmann One Base heat pumps		■	■	■
<b>Operation via</b>				
– Ventilation programming unit, type LB1		■	■	■
– Step switch		–	–	–
<b>Passive House Institute certified component</b>				
		■	■	■
<b>Application areas</b>				
– New build		■	■	■
– Detached house/two-family house		■	■	■
<b>Sound power level in the installation room at air flow rate</b>				
100 m <sup>3</sup> /h	dB(A)	31 to 33.5	27	29
150 m <sup>3</sup> /h	dB(A)	38.5 to 40.5	33.5 to 34.5	35.5 to 37
200 m <sup>3</sup> /h	dB(A)	44 to 45.5	40 to 41	41.5 to 43
250 m <sup>3</sup> /h	dB(A)	–	45.5	43.5 to 49
300 m <sup>3</sup> /h	dB(A)	–	–	48 to 48.5
325 m <sup>3</sup> /h	dB(A)	–	50 to 50.5	–
350 m <sup>3</sup> /h	dB(A)	–	–	52 to 56.5
400 m <sup>3</sup> /h	dB(A)	–	–	55 to 57.5

**Filter types to ISO 16890 – EN 779**

G4 = ISO Coarse 60 %

F7 = ISO ePM1 50 %

M5 = ISO ePM10 50 %



## VITOVENT 300-C

<b>Type</b>		H32S B150
<b>Air flow rate up to approx.</b>	m <sup>3</sup> /h	150
<b>Interior up to approx.</b>	m <sup>2</sup>	90
<b>Dimensions</b>		
Length (depth)	mm	1000
Width	mm	660
Height	mm	198
<b>Weight</b>	kg	24.5
<b>Energy efficiency class</b>		
in acc. with Commission Delegated Regulation (EU) No 1254/2014		
– Manual control	Ⓜ	–
– Time control	Ⓢ	A
– Central demand-dependent control	Ⓢ	A
– Control according to local demand	Ⓢ	A
<b>Type of heat exchanger</b>		
– Cross-countercurrent		■
<b>Type of filter (outdoor air/extract air)</b>		
– Standard delivery		G4/G4
– Accessory		F7/G4
<b>Heat recovery</b>		
Heat recovery level to DIBt	%	87 (to 89)
Heat recovery level to PHI	%	84
Counter-current heat exchanger material		PETG plastic
<b>Humidity control</b>	%	–
<b>System operation with Vitocal heat pumps</b>		
		■
<b>Operation via</b>		
– Ventilation programming unit, type LB1		■
– Step switch		–
<b>Passive House Institute certified component</b>		
		■
<b>Application areas</b>		
– New build		■
– Modernisation		■
– Apartments on several floors		■
<b>Sound power level in the installation room</b>		
<b>at air flow rate</b>		
45 m <sup>3</sup> /h	dB(A)	27
75 m <sup>3</sup> /h	dB(A)	33
105 m <sup>3</sup> /h	dB(A)	42
110 m <sup>3</sup> /h	dB(A)	38
150 m <sup>3</sup> /h	dB(A)	45

### Filter types to ISO 16890 – EN 779

G4 = ISO Coarse 65 %

F7 = ISO ePM1 70 %

M5 = ISO ePM10 50 %

**VITOVENT 200-C**

Type		H11S A200 (R)/(L)	H11E A200 (R)/(L)
<b>Air flow rate up to approx.</b>	m <sup>3</sup> /h	200	200
<b>Interior up to approx.</b>	m <sup>2</sup>	120	120
<b>Dimensions</b>			
Length (depth)	mm	1000	1000
Width	mm	650	650
Height	mm	300	300
<b>Weight</b>	kg	18	20
<b>Connector layout</b>		Right or left	Right or left
<b>Energy efficiency class</b>			
in acc. with Commission Delegated Regulation (EU) No 1254/2014			
– Manual control	⊕	A	B
– Time control	⊙	A	B
– Central demand-dependent control	⊖	A	A
<b>Type of heat exchanger</b>			
– Cross-counter-current		■	
– Enthalpy cross-counter-current			■
<b>Type of filter (supply air/extract air)</b>			
– Standard delivery		G4/G4	F7/M5
– Accessory		F7/G4	–
<b>Heat recovery</b>			
Rate of temperature change to ErP	%	89	80
Heat recovery level to DIBt	%	90	79
Heat recovery level to PHI	%	85	78
Material, counter-current heat exchanger/enthalpy heat exchanger		PET	PEM
<b>Humidity control</b>	%	–	Up to 80
<b>System operation with Vitocal heat pumps</b>			
		■	■
<b>Operation via</b>			
– Ventilation programming unit, type LB1		■	■
– Step switch		■	■
<b>Passive House Institute certified component</b>			
		–	–
<b>Application areas</b>			
– New build		Optional	Optional
– Modernisation		■	■
– Apartments on several floors		■	■
<b>Sound power level in the installation room at air flow rate</b>			
140 m <sup>3</sup> /h	dB(A)	47	47
200 m <sup>3</sup> /h	dB(A)	54	54

**Filter types to ISO 16890 – EN 779**

G4 = ISO Coarse 65 %

F7 = ISO ePM1 70 %

M5 = ISO ePM10 50 %





### VITOVENT 200-D

Type		HR B55	HRM B55	HRV B55
<b>Air flow rate up to</b>	m <sup>3</sup> /h	55	55	45
<b>Individual rooms up to approx.</b>	m <sup>2</sup>	25	25	25
<b>Dimensions</b>				
Length (depth)	mm	340	340	340
Width	mm	340	340	340
Height	mm	70	70	70
<b>Weight</b>	kg	4	4	4.3
<b>Energy efficiency class</b>				
in acc. with Commission Regulation (EU) No 811/2013				
– Manual control		B	B	B
– Time control		–	–	–
– Central demand-dependent control		–	–	–
– Control according to local demand		–	A	A
<b>Filter classes to EN 779</b>				
– Outdoor air filter		F7	F7	F7
– Extract air filter		G4	G4	G4
<b>Heat recovery</b>				
Rate of temperature change to ErP	%	75	75	75
Heat recovery level to DIBt	%	83	83	83
<b>Application areas</b>				
– New build		■	■	■
– Modernisation		■	■	■
– Apartments on several floors		■	■	■
<b>Sound power level in the installation room</b>				
<b>at air flow rate</b>				
15 m <sup>3</sup> /h	dB(A)	25.0	25.0	25.0
30 m <sup>3</sup> /h	dB(A)	31.0	31.0	31.0
45 m <sup>3</sup> /h	dB(A)	41.8	41.8	41.8
55 m <sup>3</sup> /h	dB(A)	45.5	45.5	45.5



**VITOVENT 100-D**

<b>Type</b>		H00E A45
<b>Air flow rate</b>		
Reduced ventilation (stage 1)	m <sup>3</sup> /h	18
Standard ventilation (stage 2)	m <sup>3</sup> /h	28
Comfort ventilation (stage 3)	m <sup>3</sup> /h	38
Intensive ventilation (stage 4)	m <sup>3</sup> /h	46
<b>Dimensions</b>		
Width	mm	200
Height	mm	200
Depth (internal cover)	mm	45
Core drilling diameter	mm	162
Wall thickness	mm	325
<b>Weight</b>	kg	4.6
<b>Energy efficiency class</b>		
in acc. with Commission Delegated Regulation (EU) No 1254/2014		
– Manual control		A
– Time control		A
– Central demand-dependent control		A
– Control according to local demand		A+
<b>Heat recovery level to DIBt</b>	%	81
<b>Application areas</b>		
– New build		■
– Modernisation		■
– Apartments on several floors		■
<b>Sound power level</b>		
– Stage 1	dB(A)	29
– Stage 2	dB(A)	37
– Stage 3	dB(A)	46
– Stage 4	dB(A)	49

**Notes:**

Wiring: star or series configuration, operating voltage: 42 V, cable connection: 4-core cable type LiYY, max. cable length: 100 m (with 0.75 mm<sup>2</sup>)

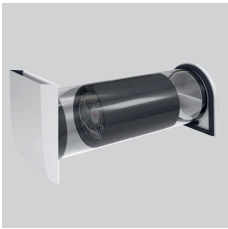

## VITOVENT 050-D

<b>Type</b>		H20E A43
<b>Air flow rate</b>		
Reduced ventilation (stage 1)	m <sup>3</sup> /h	16
Standard ventilation (stage 2)	m <sup>3</sup> /h	22
Comfort ventilation (stage 3)	m <sup>3</sup> /h	30
Intensive ventilation (stage 4)	m <sup>3</sup> /h	43
<b>Dimensions</b>		
Width x height x depth (internal wall cover)	mm	190 x 214 x 40
Core drilling diameter	mm	From 162
Wall thickness	mm	From 305
<b>Weight</b>	kg	4.6
<b>Energy efficiency class</b>		
in acc. with Commission Delegated Regulation (EU)		
No 1254/2014		
– Manual control	Ⓢ	A
– Time control	Ⓢ	–
– Central demand-dependent control	Ⓢ	A
– Control according to local demand	Ⓢ	–
<b>Heat recovery level to DIBt</b>	%	82
<b>Application areas</b>		
– New build		■
– Modernisation		■
– Apartments on several floors		■
<b>Sound power level</b>		
– Stage 1	dB(A)	32
– Stage 2	dB(A)	43
– Stage 3	dB(A)	52
– Stage 4	dB(A)	52

### Notes:

Wiring: series configuration, operating voltage: 12 V, cable connection: 3-core cable type LiYY, max. cable length: 100 m (with 0.75 mm<sup>2</sup>)



**VITOVENT 200-P**

<b>Principle</b>		Displacement
<b>Air flow rate up to</b>	m <sup>3</sup> /h	800
<b>Individual rooms up to approx.</b>	m <sup>2</sup>	90
<b>Number of people</b>		Up to 30
<b>Rated voltage</b>		230 V/50 Hz
<b>Diameter of connector for outdoor and exhaust air</b>		180 mm
<b>Dimensions</b>		
Width	mm	1700
Height	mm	2000
Depth	mm	675
<b>Weight</b>		
Ventilation module (right)	kg	310
Supply/extract air module (left)	kg	170
		140
<b>Energy efficiency class</b>		Heat recovery of up to 96 %
<b>Filter classes</b>		
– Outdoor air filter		F7
– Recirculation air filter		HEPA H14
<b>Heat recovery/humidity control</b>		
Rate of temperature change		80.5
Rate of humidity change	%	52.4
Heat exchanger material	%	PETG
<b>Sound power level in the installation room at air flow rate</b>		
90 m <sup>3</sup> /h	dB(A)	≤ 40.0





Viessmann One Base networks digital services with complete energy systems, including heat pumps, ventilation systems, power storage units and photovoltaic systems.

**VISSMANN  
ONE BASE**

<b>Value added services</b>	Wärme Leads   ViShare* Service Plus   Strom Logistik Plus   FörderProfi ...
<b>Digital services</b>	ViCare   ViGuide   ...
<b>Connectivity &amp; platforms</b>	Connectivity Inside   Energy Management Inside   Vitoconnect   @wibutler   GridBox   ...
<b>Products &amp; systems</b>	

Seamless integration of products and systems with digital services and value added services for system users and trade partners

\* The operator and contractual partner of the ViShare Energy Community is Energy Market Solutions GmbH (EMS), a subsidiary of the Viessmann Group.

We are Viessmann, a family business. Founded in 1917 as a heating technology manufacturer, today we are the world's leading provider of sustainable climate (heating, cooling and air quality) and renewable energy solutions.

Our integrated range of solutions seamlessly connects products and systems via digital platforms and services, creating an individualised feel-good climate for our users. All our activities are driven by the company mission statement "We create living spaces for generations to come." This is the responsibility that we, the 13,000 members of the Viessmann family, take on every day together with our (trade) partners.



**We create living spaces for generations to come.**



Number 1 Trade Partner – for the 16th consecutive time

**Practical partnership**

As part of its comprehensive range, Viessmann also offers a wide selection of value added services. These include an extensive training and further development programme for trade partners at the well equipped training facilities of the Viessmann Academy.

With its new digital services, Viessmann offers innovative solutions such as the operation and monitoring of heating systems by smartphone. Users benefit from greater reassurance and convenience, whilst contractors can keep a constant eye on the systems for which they are responsible.



As a family company in its fourth generation, we take a long term view: we create living spaces for generations to come. This mission statement guides the actions of all employees in the large Viessmann family.

#### VISSMANN GROUP IN FIGURES

1917

— Viessmann was founded

13 000

— employees

3.4

— Group turnover in billions of euros

54

— export share in percent

22

— manufacturing sites in  
12 countries

74

— sales companies in  
43 countries

120

— sales offices worldwide



Viessmann Climate Solutions SE  
35107 Allendorf (Eder)  
Germany  
Telephone: +49 6452 70-0  
[www.viessmann.de](http://www.viessmann.de)

**Your trade partner**

12/2022 EN

Copyright Viessmann.  
Duplication and alternative use  
only with prior consent.  
Subject to modifications.

---